

X1-8 ACCESS CONTROL

Quick Start Guide

MOUNT THE SYSTEM

The metal enclosure for the X1-8 system must be mounted to a wall, backboard, or other flat surface. It is not necessary to remove the PCB when installing the enclosure.

WIRE THE ELECTRONIC LOCK

This section only applies to the X1 Door Controller and the XD Door Controller Modules.

Form C Relay

The X1 system provides a Form C (SPDT) relay that is rated for 1 Amp.

Diode

Connect the included diode as close to the magnetic lock or door strike as possible to prevent inductive kickback to the Door Controller. Observe polarity when connecting the diode.

Wet/Dry Jumper

Putting the jumper on the top two terminals will place it in the dry condition. Putting the jumper on the bottom two terminals will place it in the wet condition.



Note: The XD Door Controller only wires dry because it does not have a wet/dry jumper.

Magnetic Lock - Normally Closed and Dry

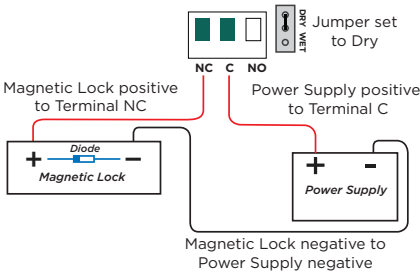

Door Strike - Normally Open and Dry

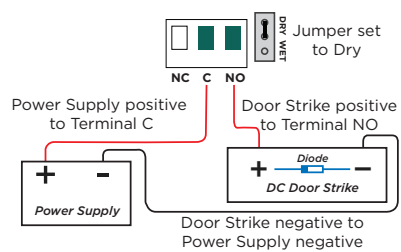

Magnetic Lock - Normally Closed and Wet

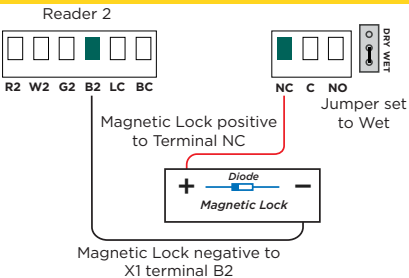

Door Strike - Normally Open and Wet

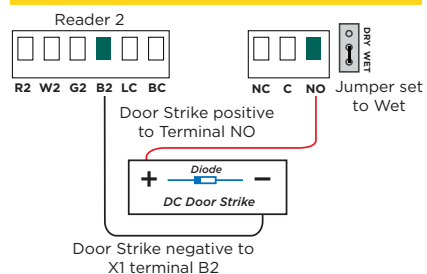

CONNECT A CARD READER

The card reader wires the same for the X1 Door Controller and the XD Door Controller Modules.

The X1 Series system provides direct 12 VDC output to the reader on the RED terminal connection.

Terminal Name	Wiegand Function	OSDP Function
R1 & R2	12V+	DC +
W1 & W2	Data 1	B (485 +)
G1 & G2	Data 0	A (485 -)
B1 & B2	12V- (ground)	DC -
LC	LED Control	N/A
BC	Wiegand Buzzer Control	N/A

WIRE THE INPUTS

The inputs wire the same for the X1 Door Controller and the XD Door Controller Modules.

Door Switch (DS) - Normally Closed

Connect a door contact or door position switch to indicate status of door, whether it is open or closed.

Request to Exit (RX) - Normally Open

Connect a motion sensing device or a mechanical switch to provide RX capability to the system.

Custom Input (CI) - Normally Open

This input triggers a custom action.

Ground (G)

This terminal is the ground for the inputs.

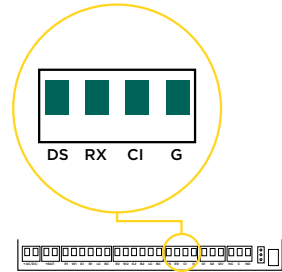

WIRE THE OUTPUTS

This section only applies to the X1 Door Controller.

Use these terminals for local outputs or door alarms such as sounders, lights, or sirens. These are 12 VDC outputs.

Aux Output 1 & 2 (O1 & O2)

Attach the negative wire of the device here.

12V+ (12V)

Attach the positive wire of the device here.

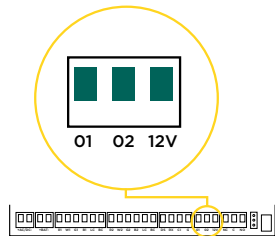

DETERMINE COMMUNICATION

This section only applies to the X1 Door Controller.

For more detailed information, follow the QR code at the end of this guide to see the full X1-8 Installation and Programming Guide: LT-2289.

Ethernet Connection

Connect an Ethernet cable from the LAN/WAN connection to the X1 Ethernet port.

Cellular Connection (Optional)

1. Attach the included standoff to the Door Controller.
2. Plug the Cell Module onto the standoff.
3. Plug the Cell Module into the Cell Header.
4. Attach the Cell Module Antenna cable to the antenna connector.
5. Run the cable around the 505-12 Power Supply.
6. Attach the antenna with the nut on the inside of the enclosure and the washers on the inside and the top of the enclosure.

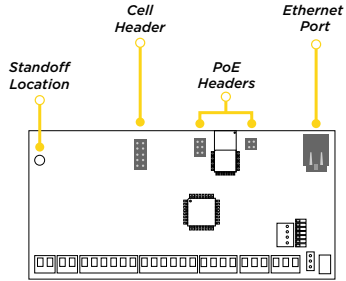

Wi-Fi Connection

If not connecting over Ethernet, the Door Controller will connect over Wi-Fi after power up.

For installing the Wi-Fi Antenna, follow the QR code at the end of this guide to see the full X1-8 Installation and Programming Guide: LT-2289.



Note: You can connect over Ethernet or Wi-Fi, but not both at the same time.

APPLY POWER

This section only applies to the X1 Door Controller.



Warning: Refer to your local state regulations before connecting to building power. Wiring methods shall be in accordance with NEC, NFPA72, ANSI, and with all Authority Having Jurisdiction.

Ground the System

Be sure to secure the green wire lead to an earth ground. Connect to a cold water pipe, ground rod, or building ground when available. Connection to an electrical ground or conduit can also be used. Gas pipes or sprinkler pipes should not be used.

Connect AC Power

Connect an unswitched 120 V AC 60 Hz power source to the transformer leads on the 505-12. Remove desired knockouts for power input.

Wire the Battery

The battery leads for the X1-8 come pre-wired.

CONNECTION SETTINGS

If no network cable is attached, thirty seconds after power up the X1 broadcasts an SSID of **DMPX1** followed by the system's serial number. No password is required to join the SSID.

Configure Options

1. Connect to the X1 SSID using a device capable of launching a browser (cell phone, laptop, etc.).
2. Enter **192.168.1.1** into the web browser.
3. For Wi-Fi, in the **Wi-Fi** options, enter the customer's network information. For Network, the **DHCP** options, make edits to the desired fields.
 - DHCP: This option is toggled on as default.
 - Static IP: Toggle off DHCP and enter the information in the required fields.
4. Select **Apply**, and the X1 will reset.

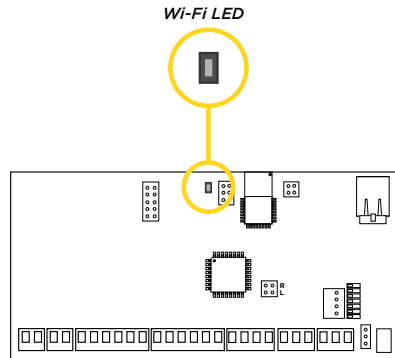

Once the X1 has reset, it will automatically connect to the customer's network with the updated settings.

PROGRAM IN DEALER ADMIN™

Go to Dealer Admin (dealer.securecomwireless.com) to program the system.

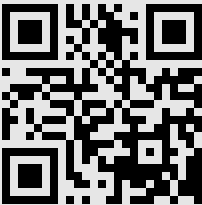

More Information

Follow the QR code for more information.

- X1-8 Installation and Programming Guide
- X1 Series Compliance Guide



INTRUSION • FIRE • ACCESS • NETWORKS

Designed, engineered, and manufactured in Springfield, Missouri
2500 North Partnership Boulevard | Springfield, Missouri 65803-8877
800.641.4282 | dmp.com