

## CellComSLCF Cellular Communicator Dialer Capture

Introduction.....	1
Basic Programming for CellComSLCF CID Dialer Capture Communication .....	1
Wiring Diagrams .....	2
Ademco Vista 128FBP .....	2
Ademco Vista 128FBPT .....	3
Bosch FPD-7024 Fire Control Panel .....	4
Firelite MS-9200UDLS .....	6
First Alert FA1600C.....	7
Silent Knight 5808.....	8
Configure a Single Path Alarm Connection..	9

### Introduction

This Application Note is designed to guide technicians through the process of installing the CellComSLCF with the Fire Panels shown below. The information provided illustrates the connection and programming of Fire Panels for CID Dialer Capture using the CellComSLCF Cellular Communicator.

- Ademco Vista 128FBP
- Ademco Vista 128FBPT
- Bosch FPD-7024 Fire Control Panel
- Firelite MS-5UD
- Firelite MS-9200UDLS
- First Alert FA 1600C
- Silent Knight 5808

### Basic Programming for CellComSLCF CID Dialer Capture Communication

This section provides the basic programming required for the CellComSLCF. Please see the CellComSL Series Installation and Programming Guide (LT-1339) for complete information.

#### Communication:

Account No: 1 -65535  
Test Time: Use entries between 12:00 to 11:59 and then choose AM or PM.  
Cell TST DAYS: 1  
CHECKIN: 58 minutes for NFPA 72 2013 & UL 864 10th edition  
FAIL TIME: 60 minutes for NFPA 72 2013 & UL 864 10th edition

#### RECEIVER 1 PROG:

ALARM: YES  
SPV/TRBL: YES  
TEST RPT: YES  
FIRST IP ADDR: XXX.XXX.XXX.XXX  
FIRST IP PORT: Default is 2001

#### SYSTEM OPTIONS:

TIME CHG: YES  
HRS FROM GMT: # Default is 6 for CST

#### OUTPUT OPTIONS:

COM FAIL OUT: Either 1 or 2. The default is 0 (zero), which disables this output.

**Note:** This output turns on if a communicator fails to communicate with its receiver.



# APPLICATION NOTE

## Wiring Diagrams Ademco Vista 128FBP

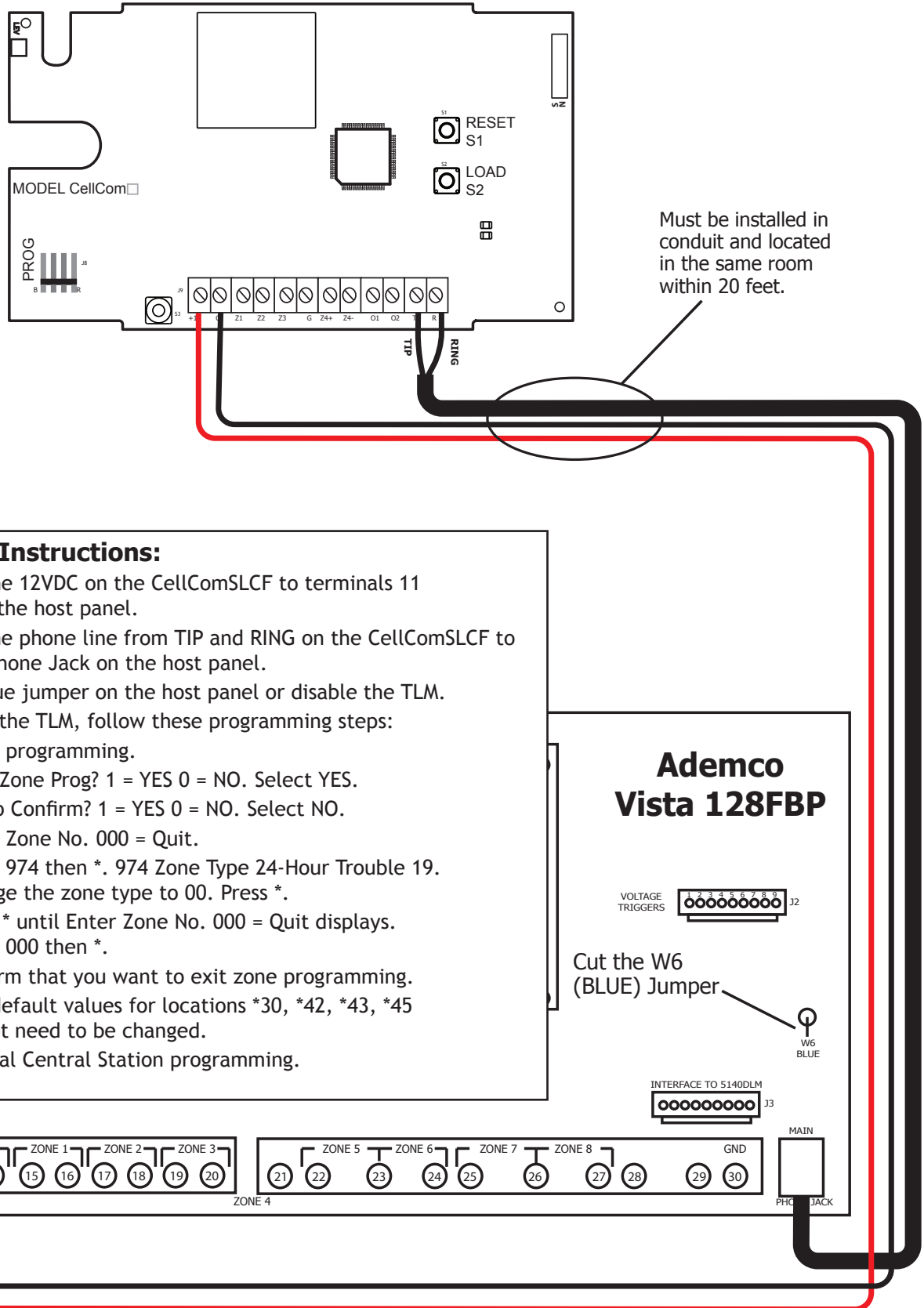

### Connection Instructions:

1. Connect the 12VDC on the CellComSLCF to terminals 11 and 12 on the host panel.
2. Connect the phone line from TIP and RING on the CellComSLCF to the Main Phone Jack on the host panel.
3. Cut the blue jumper on the host panel or disable the TLM.

To disable the TLM, follow these programming steps:

1. Enter programming.
2. \*93 - Zone Prog? 1 = YES 0 = NO. Select YES.
3. Set to Confirm? 1 = YES 0 = NO. Select NO.
4. Enter Zone No. 000 = Quit.
5. Enter 974 then \*. 974 Zone Type 24-Hour Trouble 19. Change the zone type to 00. Press \*.
6. Press \* until Enter Zone No. 000 = Quit displays. Enter 000 then \*.
7. Confirm that you want to exit zone programming.
8. The default values for locations \*30, \*42, \*43, \*45 do not need to be changed.
9. Normal Central Station programming.

### Ademco Vista 128FBP

VOLTAGE TRIGGERS 1 2 3 4 5 6 7 8 J2

Cut the W6  
(BLUE) Jumper

W6  
BLUE

INTERFACE TO 5140DLM 1 2 3 4 5 6 7 8 J3

MAIN  
PHONE JACK

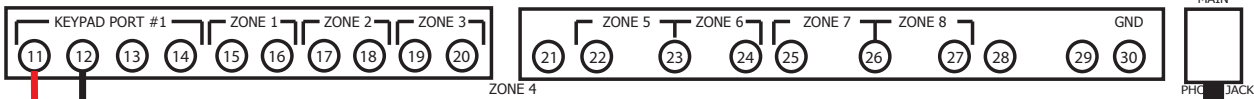

## Ademco Vista 128FBPT

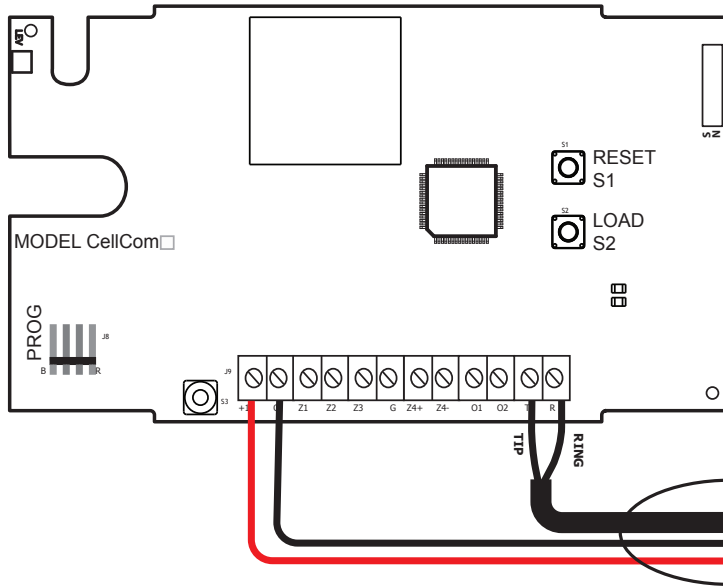

### Connection Instructions:

1. Connect the 12VDC on the CellComSLCF to terminals 11 and 12 on the host panel.
  2. Connect the phone line from TIP and RING on the CellComSLCF to the Main Phone Jack on the host panel.
  3. Check that the CellComSLCF is communicating with the host panel. If it is not, cut the blue jumper on the host panel or disable the TLM.
- To disable TLM, follow these programming steps:

1. Enter programming.
2. \*93 - Zone Prog? 1 = YES 0 = NO. Select YES.
3. Set to Confirm? 1 = YES 0 = NO. Select NO.
4. Enter Zone No. 000 = Quit. Enter 974 then \*.
5. 974 Zone Type 24-Hour Trouble 19. Change the zone type to 00. Press \*.
6. Press \* until Enter Zone No. 000 = Quit displays. Enter 000 then \*.
7. Confirm that you want to exit zone programming.
8. The default values for locations \*42 and \*45 do not need to be changed. Locations \*30 and \*43 do not exist on this panel.
9. Normal Central Station programming.

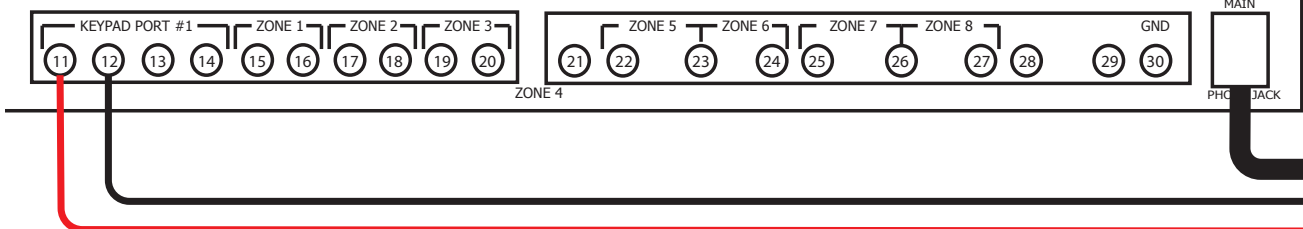
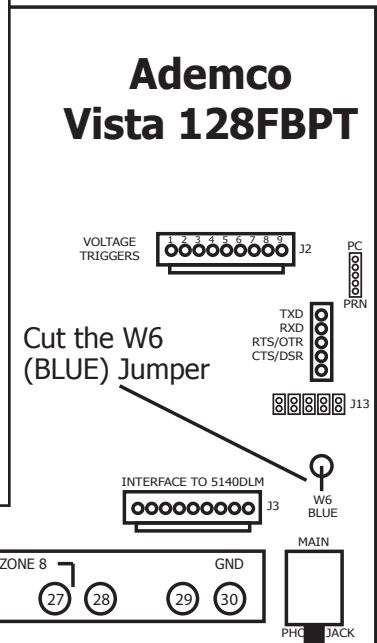

# APPLICATION NOTE

## Bosch FPD-7024 Fire Control Panel

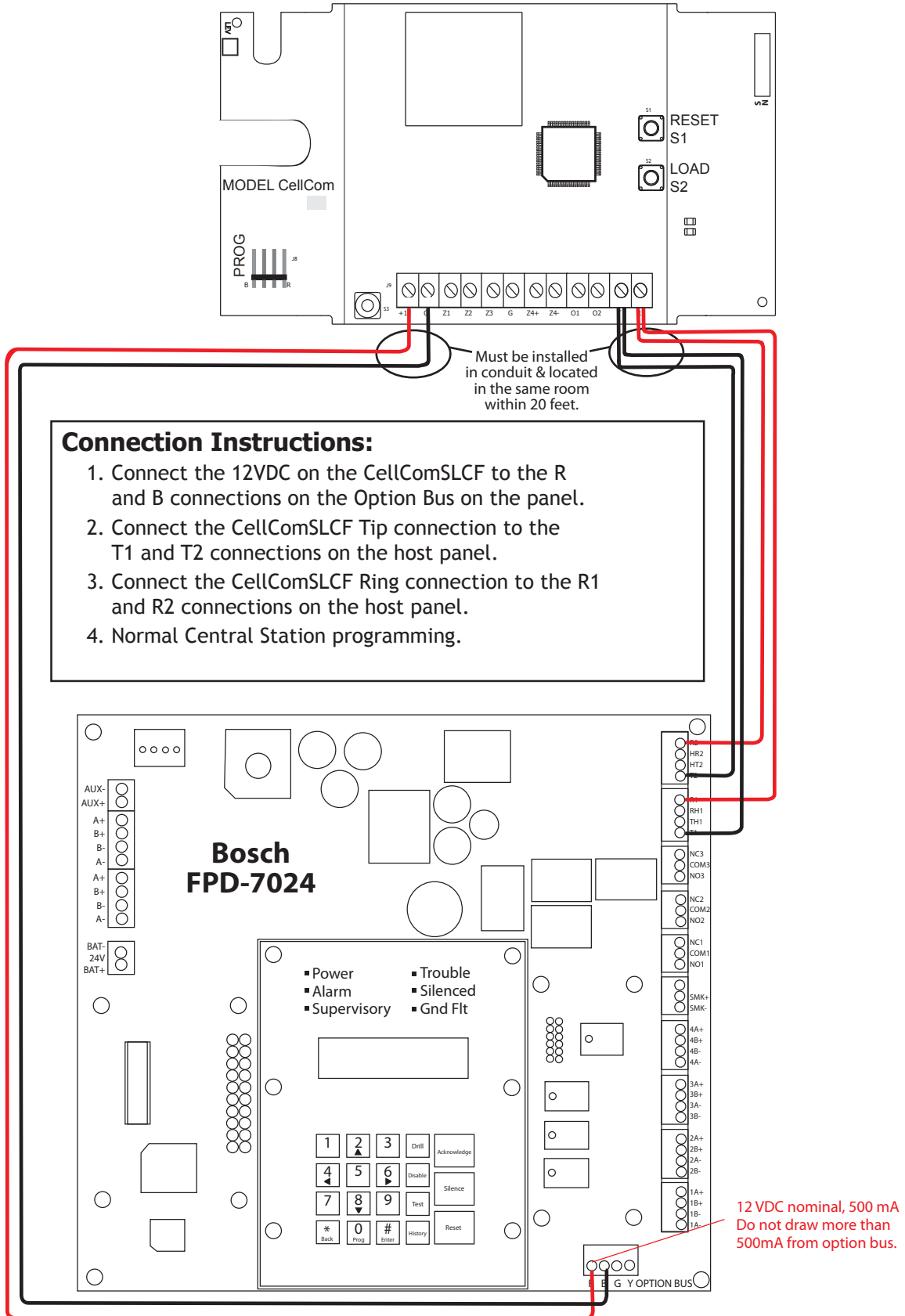

## Firelite MS-5UD

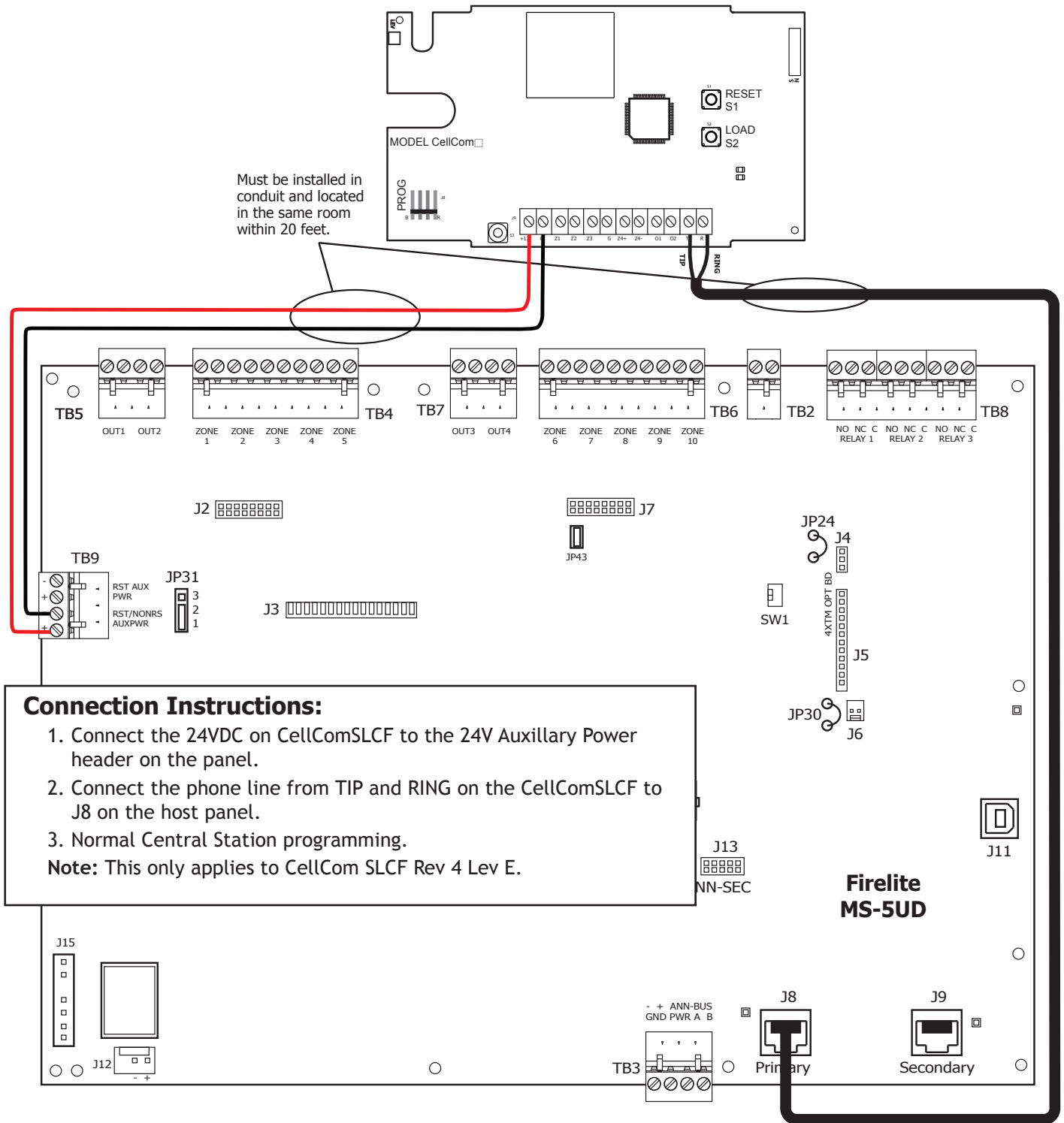

# APPLICATION NOTE

## Firelite MS-9200UDLS

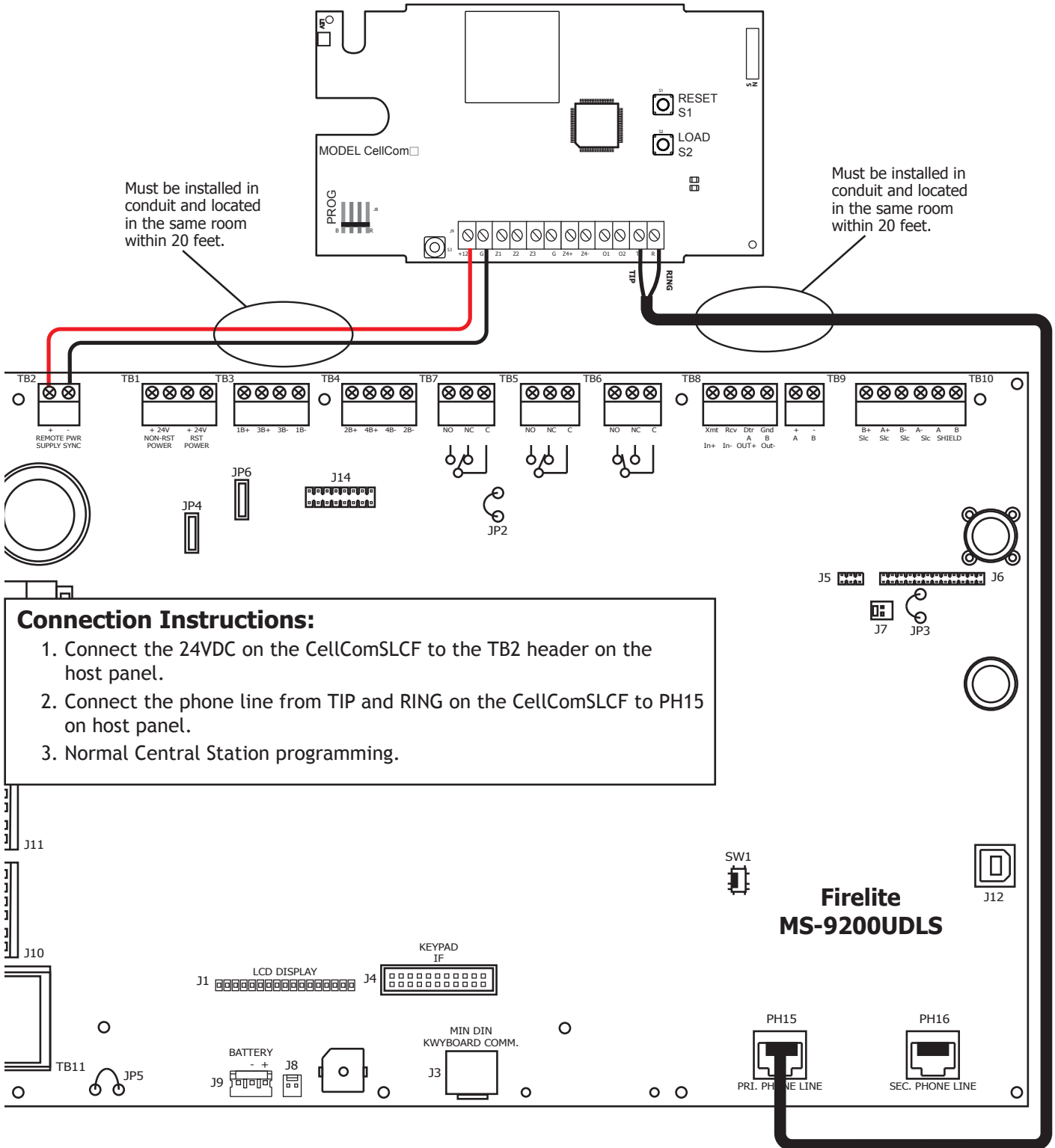

## First Alert FA1600C

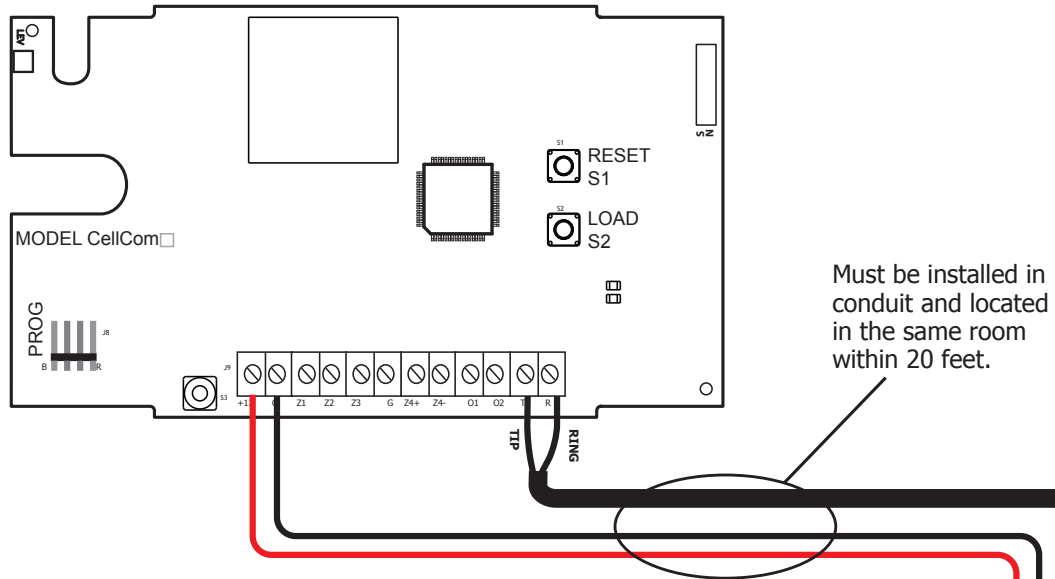

### Connection Instructions:

1. Connect the 12VDC on the CellComSLCF to terminals 11 and 12 on the host panel.
2. Connect the phone line from TIP and RING on the CellComSLCF to the Main Phone Jack on the host panel.
3. Cut the blue jumper on the host panel.
4. Follow these programming steps:
  1. \*30 Main dialer. Default is 0 changed that to 1 for Touch Tone.
  2. \*42 Dial tone pause 0=5 seconds
  3. \*43 Dial tone detection was a 0 which is pause, then dial. Changed that to a 1=wait for true dial tone.
  4. \*45 Verified the proper format which is 1=Contact ID
  5. Normal Central Station programming.

### First Alert FA 1600C

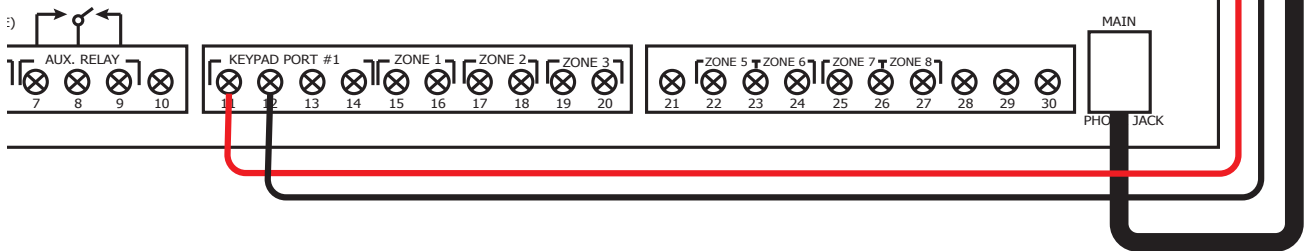
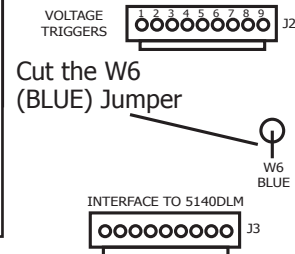

# APPLICATION NOTE

## Silent Knight 5808

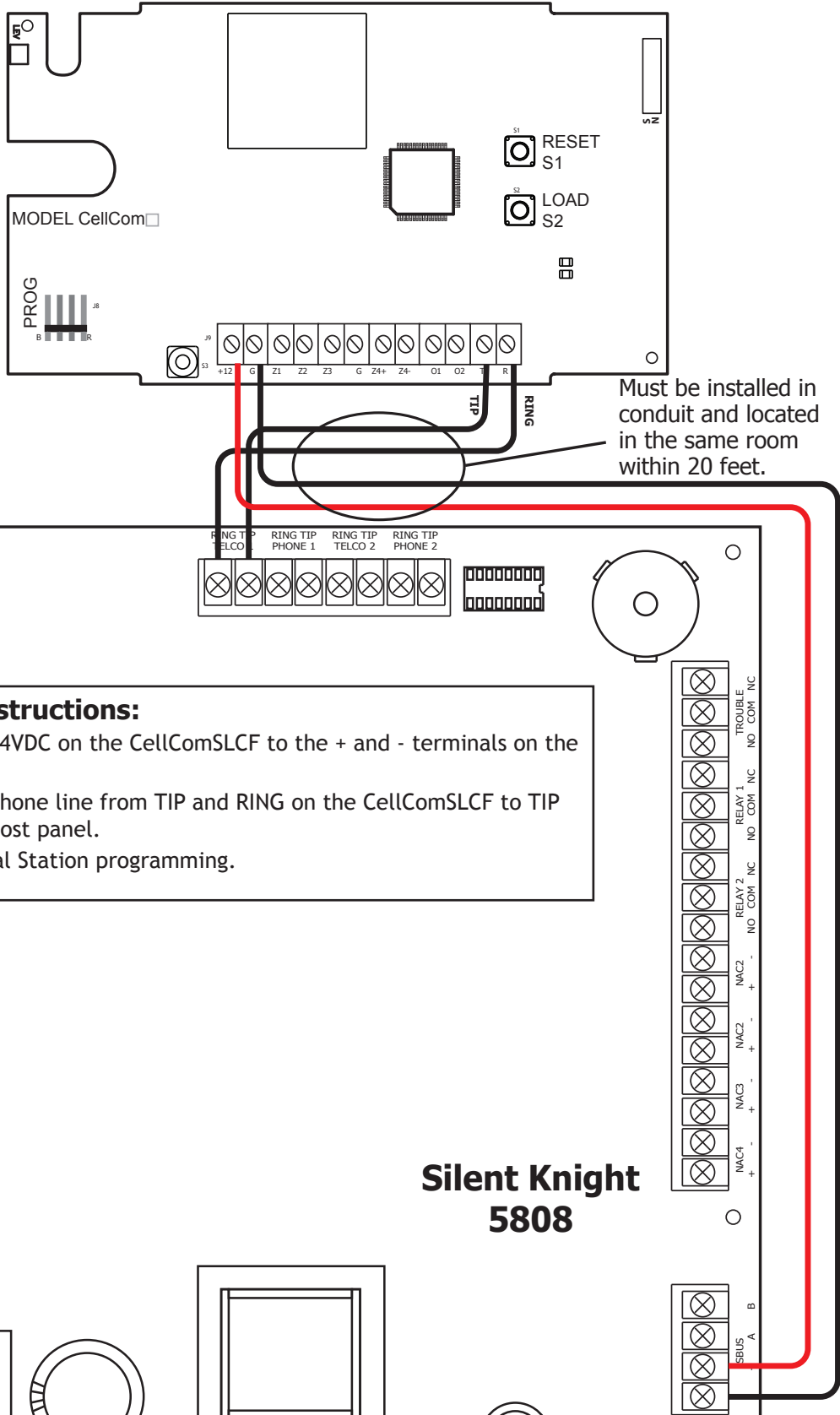

**Silent Knight  
5808**



# Configure a Single Path Alarm Connection

Some fire panels provide two telco connections. Because the CellComSLCF is equipped with a single telco connection, the fire panel must be configured accordingly. One method of installation is to disable the second telco connection. If this option is not applicable due to panel limitations, both TIP and RING connections may be connected from the panel into the CellComSLCF. The CellComSLCF has the capability of monitoring and providing a dial tone to both telco connections.

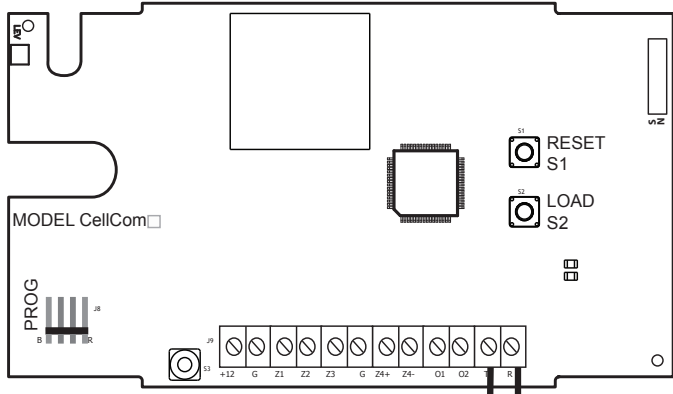

1. Connect both phone lines on the host panel to TIP and RING on the CellComSLCF.

