

INSTALLATION GUIDE

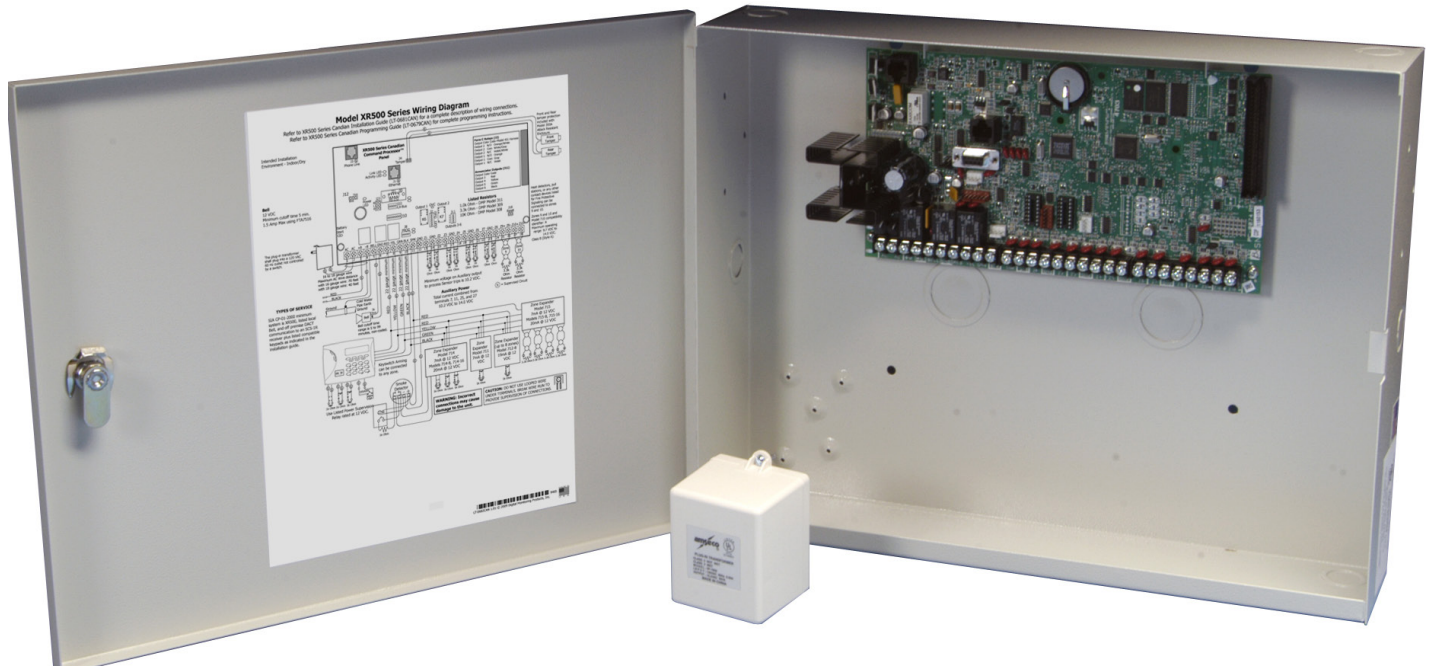

XR500 SERIES CANADIAN COMMAND PROCESSOR™ PANEL



**MODEL XR500, XR500N, XR500E
CANADIAN COMMAND PROCESSOR
INSTALLATION GUIDE**

INDUSTRY CANADA NOTICE

This Class A digital apparatus complies with Canadian ICES-003.

© 2011 Digital Monitoring Products, Inc.

Information furnished by DMP is believed to be accurate and reliable.
This information is subject to change without notice.

Product Specifications

1.1	Power Supply	1
1.2	Communication	1
1.3	Panel Zones	1
1.4	Keypad Bus.....	1
1.5	LX-Bus™	1
1.6	Outputs	1
1.7	Enclosure Specifications	1

Panel Features

2.1	Description.....	2
2.2	Zone Expansion	2
2.3	Output Expansion	2
2.4	Central Station Communication.....	2
2.5	Encrypted Communications (XR500N/XR500E only).....	2
2.6	Caution Notes	3
2.7	Compliance Instructions	3

System Components

3.1	Description.....	3
3.2	Wiring Diagram	4
3.3	Lightning Protection.....	4
3.4	Accessory Devices	5
3.4	Accessory Devices (continued).....	6

Installation

4.1	Mounting the Enclosure.....	7
4.2	Mounting Keypads and Zone Expansion Modules.....	8
4.3	Connecting LX-Bus and Keypad Bus Devices	9
4.4	Wireless Keypad Association	9

Primary Power Supply

5.1	AC Terminals 1 and 2	9
5.2	Transformer Types	9
5.3	J12 3-Pin Header for Transformer Types	9

Secondary Power Supply

6.1	Battery Terminals 3 and 4	10
6.2	Earth Ground (GND)	10
6.3	Battery Only Restart	10
6.4	Battery Replacement Period.....	10
6.5	Discharge/Recharge.....	10
6.6	Battery Supervision.....	10
6.7	Battery Cutoff.....	10
6.8	XR500 Series Canadian Power Requirements	11
6.9	Standby Battery Selection	13

Bell Output

7.1	Terminals 5 and 6	14
-----	-------------------------	----

Keypad Bus

8.1	Description.....	14
8.2	Terminal 7 - RED	14
8.4	Terminal 9 - GREEN	14
8.5	Terminal 10 - BLACK	14
8.6	J8 Programming Connection	14
8.7	OVC LED.....	14

TABLE OF CONTENTS

Smoke and Glassbreak Detector Output	
9.1 Terminals 11 and 12	14
9.2 Current Rating.....	14
Protection Zones	
10.1 Terminals 13–24	15
10.2 Dual EOL	15
10.3 Zone Response Time.....	15
10.4 Keyswitch Arming Zone	15
Powered Zones for 2-Wire Smoke Detectors	
11.1 Terminals 25–26 and 27–28	15
11.2 Compatible 2-Wire Smoke Detector Chart.....	16
Dry Contact Relay Outputs	
12.1 Description.....	17
12.2 Contact Rating	17
12.3 Model 431 Output Harness Wiring.....	17
Annunciator Outputs	
13.1 Description.....	17
13.2 Model 300 Harness Wiring.....	17
13.3 Model 860 Relay Module	17
J23 6-Pin Header	
14.1 Description.....	18
J22 LX-Bus Expansion Connector	
15.1 Description.....	18
15.2 J22 LX-Bus Header	18
15.3 LX-Bus Interface Cards.....	19
15.4 LX-Bus LEDs.....	19
15.5 OVC LED.....	19
J21 Serial Connector	
16.1 Description.....	19
16.2 Computer Connection to J21	19
16.3 Serial Connector LEDs.....	19
J1 Ethernet Connector (XR500N/XR500E only)	
17.1 Description.....	20
17.2 Ethernet LEDs	20
J3 Telephone RJ Connector	
18.1 Description.....	20
18.2 J10 893A Connector.....	20
18.3 Notification	20
18.4 Phone Line Monitor.....	20
Reset and Tamper Headers	
19.1 J16 Reset Header	21
19.2 J4 Tamper Header	21
Listed Compliance Specifications	
20.1 Introduction	22

Burglary Specifications

21.1	Introduction	22
21.2	Control Outside of Protected Area	22
21.3	Bypass Reports.....	22
21.4	System Maintenance.....	22

ULC S304-06 Specifications

22.1	For Medium or High Risk Applications: Level A3	22
22.2	For Very High Risk Applications: Level A3 Plus P1.....	22
22.3	For Low Risk Applications: Level A1	23
22.4	For Low Risk Applications: Level P1.....	23
22.5	Dual Protection.....	23
22.6	Remote Arming	23
22.7	Zone Expansion	23

ULC S559-04 Specifications

23.1	For Fire Communicator Applications	23
23.2	Central Station Host Automation	23

Recommendations

24.1	ULC Burglary Installation Recommendations	24
------	---	----

False Alarm Reduction Programmable Options *

25.1	Shipping Defaults and Recommended Programming for ANSI/SIA CP-01-2010	25
25.2	Call Waiting (ANSI/SIA CP-01-2010).....	26
25.3	Occupied Premise (ANSI/SIA CP-01-2010).....	26
25.4	Entry Delay (ANSI/SIA CP-01-2010).....	26
25.5	Minimum Installation Requirements (ANSI/SIA CP-01-2010)	26

Wiring Diagrams

26.1	Rothenbuhler 5110 High Security Bell Wiring	27
26.2	LX-Bus™ Module Connection	28
26.3	Model 860 Relay Module Connection	29
26.4	Dual Zone Protection	29
26.5	Canadian Fire Communicator for FACP	30
26.6	Combination S304 and S559 System	31
26.7	System Sensor 2-Wire Smoke Detectors	32

Revisions to This Document..... 33

Listings and Approvals 34

Product Specifications

1.1 Power Supply

Transformer Input: Model 327-CAN, plug-in – Primary input: 120 VAC, 60 Hz, Secondary output: 16.5 VAC 50 VA
 Model FTA7516 ATC Frost from Standex Electronics – Primary input: 120 VAC, 60 Hz,
 Secondary output: 16 VAC 75 VA

Standby Battery: 12 VDC, 1.0 Amps Max. charging current
 Models 365, 366, 367, 368, or 369
 Replace every 3 to 5 years

Auxiliary: 12 VDC output at 1.0 Amp Max using Model 327-CAN

Bell Output: 12 VDC at 1.0 Amp Max using Model 327-CAN

Auxiliary: 12 VDC output at 1.5 Amp Max using Model FTA7516

Bell Output: 12 VDC at 1.5 Amp Max using Model FTA7516

All circuits are inherent Power Limited except the red battery wire and AC terminal.

1.2 Communication

Built-in network communication to DMP Model SCS-1R Receivers (XR500N/XR500E only)

Built-in dialer communication to DMP Model SCS-1R Receivers

Built-in Contact ID communication to DMP Model SCS-1R Receivers

Optional 893A Dual Phone Line Module with phone line supervision

Can operate as a local panel

1.3 Panel Zones

Eight 1k Ohm EOL burglary zones (zones 1 to 8)

Two 3.3k Ohm EOL powered zone with reset (zones 9 and 10)

1.4 Keypad Bus

You can connect up to a total of 16 of the following supervised keypads and expansion modules to the keypad bus:

- Alphanumeric keypads
- Single-zone detectors
- Wireless Keypads (maximum of 4)
- Four- and/or single-zone expansion modules
- Access control modules

1.5 LX-Bus™

You can connect the following devices to the LX-Bus™ provided on the panel or by the DMP 481, 462N, 462P, and 463G Interface Cards up to the maximum number of LX-Bus™ addresses. See Accessory Devices in section 3.4.

- Four- and/or single-zone expansion modules
- Relay output expansion modules
- Single-zone detectors
- Graphic annunciator modules

1.6 Outputs

The XR500 Series provide two Single Pole, Double Throw (SPDT) relay outputs which require the installation of two Model 305 relays, each rated 1 Amp at 30 VDC resistive (power limited sources only). A Model 431 Output Harness is required to use these outputs.

The XR500 Series panels also provide four open collector outputs rated for 50mA each. The open collector outputs provide ground connection for a positive voltage source. A Model 300 Output Harness is required to use these outputs.

1.7 Enclosure Specifications

The XR500 Series panels are shipped in an enclosure with a transformer, End-of-Line resistors, battery leads, user's guide, and programming sheets.

Enclosure Model	Size	Color(s)	Construction (Cold Rolled Steel)
350	17.5"W x 13.5"H x 3.5"D	Gray (G) or Red (R)	18-Gauge
350A	17.5"W x 13.5"H x 3.75"D	Gray (G)	18-Gauge with 16-Gauge door
341	12.75"W x 6.55"H x 2.9"D	Gray (G)	20-Gauge
352X	14.5"W x 32.0"H x 4.0"D	Gray (G)	16-Gauge

Panel Features

2.1 Description

The DMP XR500 Series Canadian panel is a versatile 12 VDC, combined access control, burglary, and fire communicator panel with battery backup. The XR500 Series provides eight on-board burglary zones and two on-board 12 VDC Class B powered zones. The powered zones have a reset capability to provide for 2-wire smoke detectors, relays, or other latching devices. The XR500 Series can communicate to DMP SCS-1R Receivers using digital dialer, cellular, network, or Contact ID communication.

2.2 Zone Expansion

Up to 574 additional zones are available on the XR500 Series using DMP LCD keypad remote zone capability and zone expansion modules. The panel keypad data bus supports up to sixteen supervised device addresses with each address supporting up to four programmable expansion zones.

Up to 500 zones are available using the on board LX-Bus, Model 461 Interface Adaptor with 481, 462N, 462P and 463G, and any combination of single, four, eight, or 16-zone expansion modules and single-zone LX-Bus™ detectors.

Note: Do not use shielded wire for LX-Bus or Keypad Bus circuits.

2.3 Output Expansion

In addition to the two SPDT relays and four programmable open collector outputs on the XR500 Series, you can also connect up to 25 programmable Model 716 Output Expansion Modules to each LX-Bus. These modules can provide an additional 500 programmable SPDT relays.

The XR500 Series provides 100 Output Schedules you can use for programming the 716 to perform a variety of annunciation and control functions. You can also assign the 716 outputs to any panel Output Options such as Fire Alarm, Communication Fail, or Phone Trouble Outputs. Refer to the 716 Installation Guide (LT-0183).

The LX-Bus™ also supports the Model 717 Graphic Annunciator Module. Each 717 module supplies 20 switched ground outputs that follow the state of their assigned zones.

Note: The 717 supports the first eight Keypad Bus addresses. To follow Keypad Bus addresses nine through 16, install multiple 716 modules. Refer to the 717 Installation Guide (LT-0235) and 716 Installation Guide (LT-0183).

2.4 Central Station Communication

You can program the XR500 Series panel for reporting to DMP SCS-1R Receivers using digital dialer, cellular, network, or Contact ID communication. The XR500 Series connects at the premises to a standard RJ31X or RJ38X telephone jack. Use the DMP 893A Dual Phone Line Module when connecting the XR500 Series panel to two separate phone lines.

2.5 Encrypted Communications (XR500N/XR500E only)

An XR500E panel communicates using AES encryption. If you currently have an XR500N panel installed, you may contact DMP Customer Service with the panel serial number. The serial number(s) should be sent in writing via e-mail or fax. A separate feature key is sent for each panel to activate encrypted communications using the Feature Upgrade process. Encrypted communication cannot be enabled on a standard XR500 panel. For more information on the Feature Upgrade process see the XR500 Series Canadian Programming Guide (LT-0679CAN).

2.6 Caution Notes

Throughout this guide you will see caution notes containing information you need to know when installing the panel. These cautions are indicated with a yield sign. Whenever you see a caution note, make sure you completely read and understand its information. Failing to follow the caution note can cause damage to the equipment or improper operation of one or more components in the system. See the example shown below.



Always ground the panel before applying power to any devices: The XR500 Series must be properly grounded before connecting any devices or applying power to the panel. Proper grounding protects against Electrostatic Discharge (ESD) that can damage system components.

2.7 Compliance Instructions

For applications that must conform to a local authorities installation standard or a National Recognized Testing Laboratory certificated system, please see the Listed Compliance Specifications section near the end of this guide for additional instructions.

System Components

3.1 Description

The DMP XR500 Series system is made up of an alarm panel with a built-in communicator, an enclosure, battery, one 16.5 VAC transformer, and keypads. You can use up to sixteen supervised 32-character LCD keypads; network communications and expansion interface cards; zone and output expansion modules; and initiating and indicating circuit modules. You can also connect auxiliary devices to the panel's output relays to expand the basic system control capability. Combined current requirements of additional modules may require an auxiliary power supply. Refer to the XR500 Series Power Requirements section in this guide when calculating power requirements.

3.4 Accessory Devices

Interface Adaptor and Interface Cards	
461 Interface Adaptor Card	Allows you to connect two or more expansion interface cards to the XR500 Series panel. The 461 is an expansion mother board that plugs into the panel J6 Interface Connector and is required when using two or more Interface Cards. Use combinations of Interface Cards for expanding zones, network interfacing, local printing, and connecting wireless devices.
462N Network Interface Card	Allows you to connect the XR500 Series to any compatible data network and use its communication capability in place of standard dial out telephone lines. The 462N also provides an LX-Bus™ for connecting zone and output expansion modules to the panel.
462P Printer Interface Card	Allows you to connect the XR500 Series to any compatible serial printer providing the user with real-time event recording. The 462P also provides an LX-Bus™ for connecting zone and output expansion modules.
463G Digital Cellular Communicator Card	Allows you to connect the XR500 Series to any compatible GPRS/SMS network and use its communication in place of standard dial out lines. The 463G also provides an LX-Bus™ for connecting zone and output expansion modules to the panel.
481 Expansion Interface Card	Provides one LX-Bus for connecting up to 100 zone and output expansion modules.
Expansion Modules	
710 Bus Splitter/Repeater	Allows you to increase keypad or LX-Bus™ wiring distance to 2500 feet.
711 Single Point Zone Expanders	Provides one Class B zone for connecting burglary devices.
714, 714-8, 714-16 Zone Expanders	Provides Class B zones for connecting burglary and non-powered fire devices.
712-8 Zone Expander	Provides Class B zones for connecting burglary devices.
715, 715-8, 715-16 Zone Expanders	Provides 12 VDC Class B powered zones for connecting smoke detectors, glassbreak detectors, and other 2- or 4-wire devices.
716 Output Expander	Provides four Form C relays (SPDT) and four switched grounds (open collector) for use in a variety of remote annunciation and control applications for use on the LX-Bus only.
717 Graphic Annunciator Module	Provides 20 zone following annunciator outputs (open collector) for use in a variety of remote annunciation and control applications for use on the LX-Bus only.
733 Wiegand Interface Module	Provides system codeless entry, and arming and disarming using access control readers.
734, 734N, *734N-WiFi Wiegand Interface Modules	Provides system codeless entry, and arming and disarming using access control readers.
DMP Two-Way Wireless Devices	
*1100X/*1100XH Wireless Receiver	Supports up to 500 devices in residential or commercial wireless operation.
*1100R Repeater	Provides additional range for wireless devices.
*1101 Universal Transmitter	Provides both internal and external contacts that may be used at the same time to yield two individual reporting zones from one wireless transmitter.
*1102 Universal Transmitter	Provides an external contact.
*1103 Universal Transmitter	Provides both and internal and external contacts that may be used at the same time to yield two individual reporting zones from one wireless transmitter. Requires EOL resistor for external contact.
*1105 Universal Transmitter	Provides both internal and external contacts that may be used at the same time to yield two individual reporting zones from one wireless transmitter.
*1107 Micro Window Transmitter	Provides a wireless window transmitter
*1114 Four-Zone Expander	Provides four wireless zones
*1116 Relay Output	Provides one Form C relay
*1117 LED Annunciator	Provides a visual system status indicator
*1118 Remote Indicator Light	Provides a visual indication of a Panic situation
*1119 Door Sounder	Provides a battery powered sounder
*1121 PIR Motion Detector	Provides motion detection with pet immunity.
*1125 PIR Motion Detector	Provides multiple lens configurations, dual coverage area selection, and sensitivity adjustments.

INTRODUCTION

3.4 Accessory Devices (continued)

DMP Two-Way Wireless Devices (continued)	
*1126C/*1126R/*1126W PIR Motion Detector	Ceiling mount motion detector with panel programmable sensitivity and Disarm/Disable functionality.
*1127C/*1127W PIR Motion Detector	Wall mount motion detector with panel programmable sensitivity and Disarm/Disable functionality.
*1129 Glassbreak Detector	Detects the shattering of framed glass mounted in an outside wall and provides full-pattern coverage and false-alarm immunity.
*1131 Recessed Contact	Provides a recessed contact option for door or window applications.
*1135/*1135DB Wireless Sounder	Provides a wireless sounder.
*1139 Bill Trap	Provides a silent alarm option for retail and banking cash drawers.
*1142BC Two-button Hold-up Belt Clip Transmitter	Provides two-button hold-up operation with a belt clip.
*1142 Two-button Hold-up Transmitter	Provides permanently mounted under-the-counter two-button hold-up operation.
*1145-4 (Four-Button) *1146-2 (Two-Button) *1147-1 (One-Button)	Key Fob transmitters designed to clip onto a key ring or lanyard.
*1184 Carbon Monoxide Detector	Carbon Monoxide Detector
Indicating and Initiating Devices	
*865 Supervised Style W or X Notification Circuit Module	Provides supervised alarm current when using the XR500 Series panel bell output and up to 5 Amps at 12 or 24 VDC when using a listed auxiliary power supply. The 865 can supervise 2-wire or 4-wire style circuits for opens and shorts with individual LED annunciation.
*866 Style W Notification Circuit Module	Provides supervised alarm current using the XR500 Series panel bell output and up to 5 Amps at 12 or 24 VDC when using a listed auxiliary power supply. The 866 can supervise 2-wire Style W circuits for opens and shorts.
*867 Style W LX-Bus Notification Circuit Module	Provides supervised alarm current using the XR500 Series panel bell output and up to 5 Amps at 12 or 24 VDC when using a listed auxiliary power supply. The 867 connects to the XR500 Series panel LX-Bus™ and provides one 2-wire Style W notification circuit for open and short conditions. Individual Bell Relay addresses Bell Ring styles.
*869 Dual Class A Style D Initiating Module	Provides two Class A, Style D, 4-wire initiating zones for connecting waterflow switches and other non-powered fire and burglary devices.
Accessory Modules and Keypads	
*893A Dual Phone Line Module	Allows you to supervise two standard phone lines connected to an XR500 Series panel. The 893A module monitors the main and backup phone lines for a sustained voltage drop and alerts users when the phone line is bad.
* ePAD™ Virtual Keypads	Allows users to control the security system from any computer using the Internet.
LCD keypads	Allows you to control the panel from various remote locations. Connect up to sixteen supervised Model 630F Remote Fire Command Center, 7060, 7063, 7070, 7073, 7160, 7163, 7170, 7173 Thinline™ keypads, 7060A, 7063A, 7070A, 7073A Aqualite™ keypads, to the keypad bus using terminals 7, 8, 9, and 10.
*9000 Series Wireless Keypads	Allows you to control the panel from various remote locations. Connect up to four 9060/9063 Wireless Keypads.
Addressable Smoke Detectors	
*521LX, 521LXT	Single-zone, addressable conventional smoke, smoke/heat detectors that connect to the LX-Bus. Includes remote maintenance reporting, drift compensation, and multi-criteria detection.
* These devices have not been investigated and shall not be used in commercial burglary listed installations	

Installation

4.1 Mounting the Enclosure

The metal enclosure for the XR500 Series must be mounted in a secure, dry place to protect the panel from damage due to tampering or the elements. It is not necessary to remove the XR500 Series PCB when installing the enclosure. Figure 2 shows the mounting hole locations for the Model 350/350A Enclosures. Figure 3 shows the Model 341 Small Enclosure. Figure 4 shows the Model 352X panel cabinet and 352S shelf cabinet for multiple batteries.

The 350A Attack Resistant enclosure is factory shipped with one knockout on the top left of the enclosure. As needed, additional knockouts or antenna exits may be added at the time of installation. See Figure 2 for the positions on the enclosure that can be added. Each additional knockout must be filled with conduit.

Note: When using the XR500 Series panel for listed applications, use the Model 350, 349, 341, or 352S enclosure for standby batteries. When using the 352X or 352S in listed applications, the enclosure must be surface mounted on the wall.

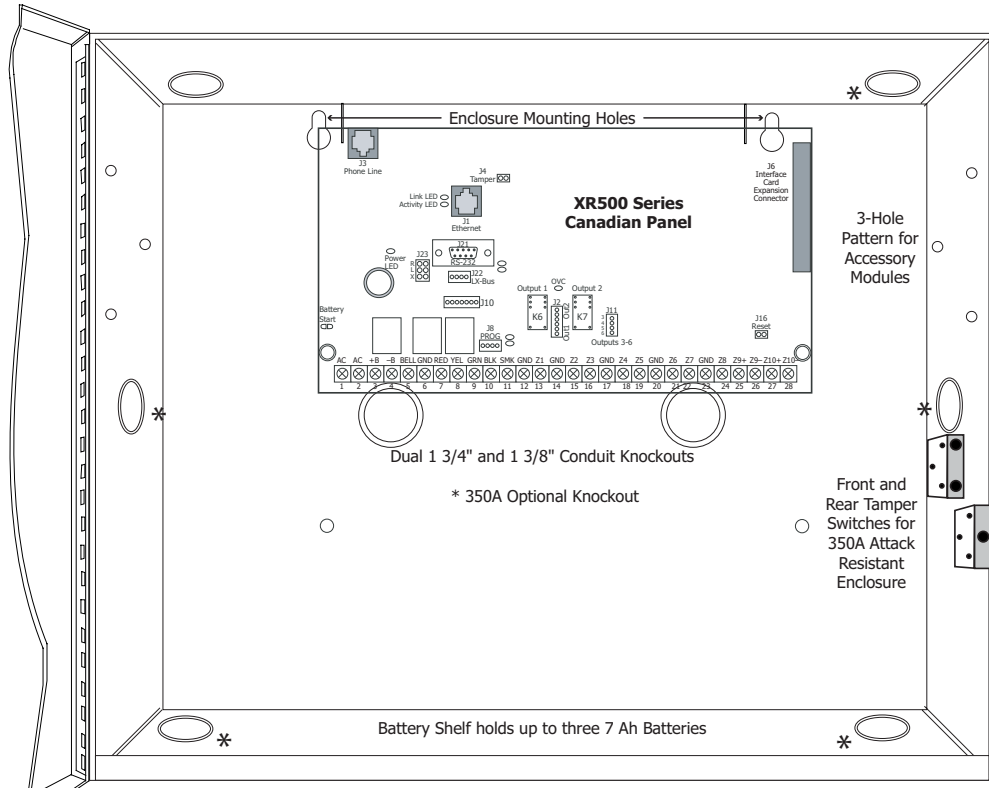

Figure 2: XR500 Series in Model 350 or 350A Enclosure

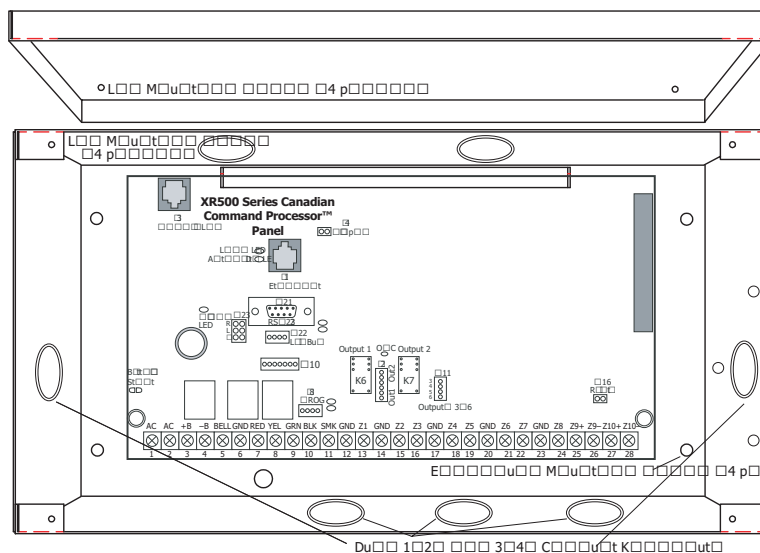

Figure 3: XR500 Series in Model 341 Enclosure

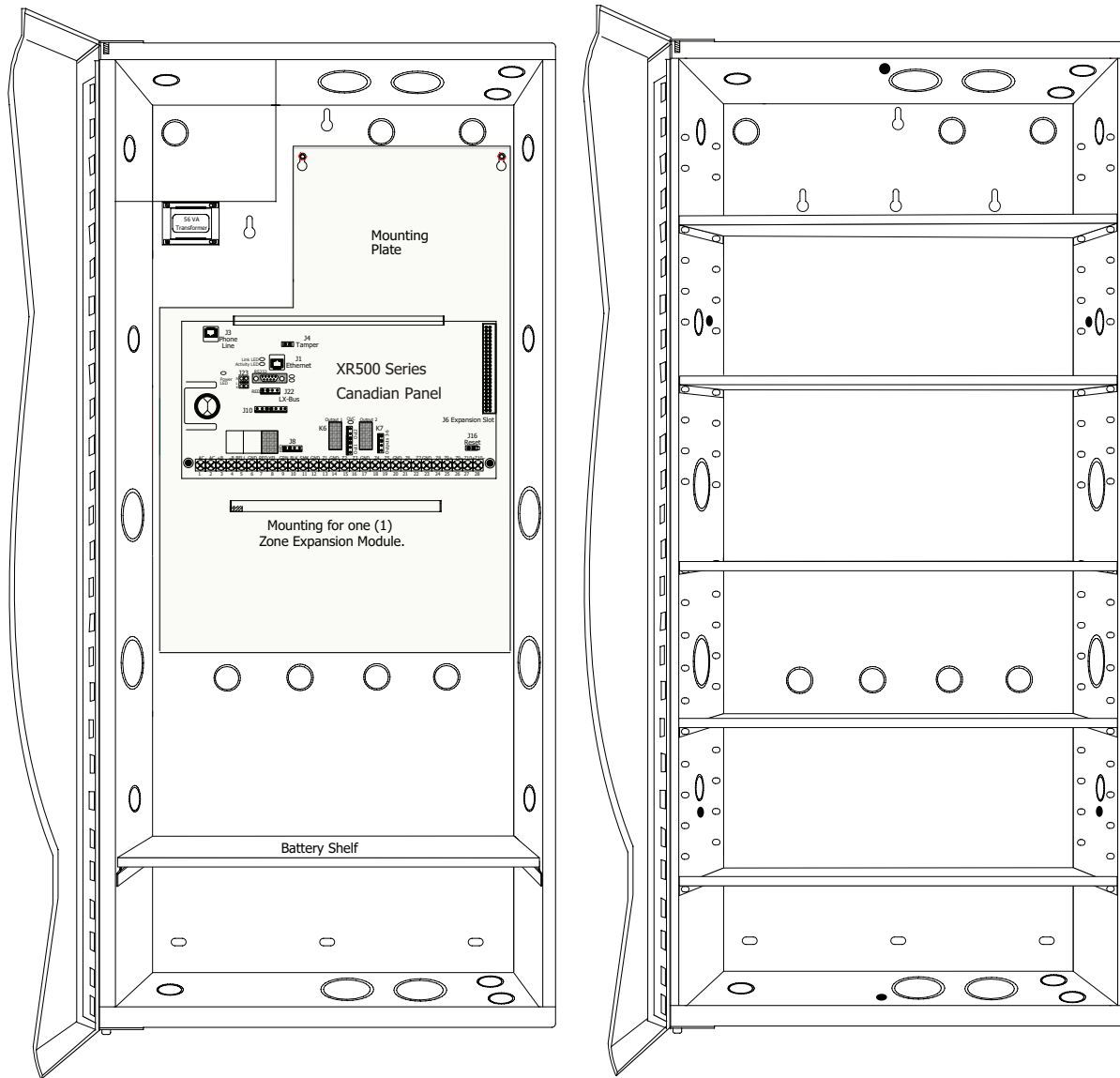

Figure 4: XR500 Series in Model 352X Enclosure and Separate 352S Enclosure with Shelves

4.2 Mounting Keypads and Zone Expansion Modules

DMP LCD keypads have removable covers that allow you to easily mount the keypad to a wall or other flat surface using the screw holes on each corner of the base. Before mounting the base, connect the keypad wire harness leads to the keypad cable from the panel and to any device wiring run to that location. Then attach the harness to the pin connector on the PC board, mount the base, and install the keypad cover making sure all of the keys extend through their respective holes.

For mounting keypads on solid walls, or for applications where conduit is required, use the Model 695 1-1/2" deep or the Model 696 1/2" deep backboxes.

The DMP 711, 712-8, 714, 715, 716, and 717 modules are each contained in molded plastic housings with removable covers. The base provides you with mounting holes for installing the unit to a wall, switch plate, or other surface.

4.3 Connecting LX-Bus and Keypad Bus Devices

Several factors determine the DMP LX-Bus™ and keypad bus performance characteristics: the wire length and gauge used, the number of devices connected, and the voltage at each device. When planning an LX-Bus™ and keypad bus installation, keep in mind the following information:

1. DMP recommends using 18 or 22-gauge **unshielded** wire for all keypad and LX-Bus circuits. **Do not use** twisted pair or shielded wire for LX-Bus and keypad bus data circuits.
2. On keypad bus circuits, to maintain auxiliary power integrity when using 22-gauge wire do not exceed 500 feet. When using 18-gauge wire do not exceed 1,000 feet. To increase the wire length or to add devices, install an additional power supply that is listed for Fire Protective Signaling, power limited, and regulated (12 VDC nominal) with battery backup.
Note: Each panel allows a specific number of supervised keypads. Add additional keypads in the unsupervised mode. Refer to the panel installation guide for the specific number of supervised keypads allowed.
3. Maximum distance for any one bus circuit (length of wire) is 2,500 feet regardless of the wire gauge. This distance can be in the form of one long wire run or multiple branches with all wiring totaling no more than 2,500 feet. As wire distance from the panel increases, DC voltage on the wire decreases. Maximum number of LX-Bus devices on the first 2,500 foot circuit is 40 devices.
4. Maximum voltage drop between the panel (or auxiliary power supply) and any device is 2.0 VDC. If the voltage at any device is less than the required level, add an auxiliary power supply at the end of the circuit. When voltage is too low, the devices cannot operate properly.

For additional information refer to the LX-Bus/Keypad Bus Wiring Application Note (LT-2031).

Expansion Interface Cards (Models 481, 462N, 462P, and 463G)

The LX-Bus provided on these cards requires only a 4-wire cable between the card and any devices connected to the bus. You can connect devices (zone or output expansion modules) together on the same cable or provide separate runs back to the card. Each LX-Bus provides up to 100 zones or outputs.

Note: Do not use twisted pair or shielded wire when connecting an LX-Bus or keypad bus.

4.4 Wireless Keypad Association

Enable Wireless Keypad Association operation on both the keypad and panel.

To enable association operation in the keypad, access the Installer Options Menu (3577 (INST)) and select RF Survey). The keypad logo LEDs turn on Red until association is successful.

To enable association operation in the XR500 panel, reset panel 3 times within 12 seconds. Allow the keypad bus Transmit/Receive LEDs to turn back on between each reset.

For 60 seconds the panel listens for wireless keypads that are in the Installer Options Menu (3577 CMD) and have not been programmed, or associated into another panel.

Those keypads are assigned to the first open device position automatically based upon the order in which they are detected. The keypad logo turns Green to indicate it has been associated with the panel.

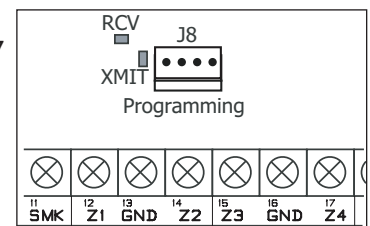

Figure 5: Keypad Bus LEDs

Primary Power Supply

5.1 AC Terminals 1 and 2

Connect the transformer wires to terminals 1 and 2 on the panel. Use no more than 70 ft. of 16 gauge or 40 ft. of 18 gauge wire between the transformer and the XR500 Series.



Always ground the panel before applying power to any devices: The XR500 Series must be properly grounded before connecting any devices or applying power to the panel. Proper grounding protects against Electrostatic Discharge (ESD) that can damage system components. See the Earth ground section.

5.2 Transformer Types

Use Model 327-CAN (16.5 VAC 50 VA) plug-in or Model FTA7516 from ATC Frost.



The transformer must be connected to an unswitched 120 VAC 60 Hz electrical outlet with at least .87A of available current. **Never share the transformer output with any other equipment.**

5.3 J12 3-Pin Header for Transformer Types

Place the jumper on the left two pins for a Maximum 2 Amp (Bell=1 Amp; Aux=1 Amp) when using the Model 327-CAN plug-in transformer (default).

Use an ATC Frost FTA7516 transformer and place the jumper on the right two pins for a Maximum, 3 Amps (Bell=1.5 Amp; Aux=1.5 Amp).

Secondary Power Supply

6.1 Battery Terminals 3 and 4

Connect the black battery lead to the negative battery terminal. The negative terminal connects to the enclosure ground internally through the XR500 Series circuit board. Connect the red battery lead to the battery positive terminal. Observe polarity when connecting the battery.

You can add a second battery in parallel using the DMP Model 318 Dual Battery Harness. **DMP requires each battery be separated by a PTC in the battery harness wiring to protect each battery from a reversal or short within the circuit.** See Figure 6.

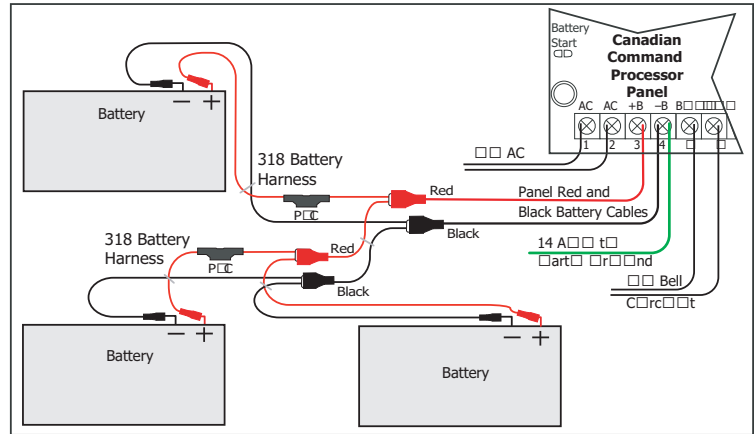

Figure 6: Wiring Multiple Batteries



Use sealed lead-acid batteries only: Use the DMP Model 365 (12 VDC 9 Ah), DMP Model 367 (12 VDC 7.7 Ah), Model 366 (12 VDC 18 Ah), Model 368 (12 VDC 4.5 Ah), or Model 369 (12 VDC 7 Ah) sealed lead-acid rechargeable battery. Batteries supplied by DMP have been tested to ensure proper charging with DMP products.

GEL CELL BATTERIES CANNOT BE USED WITH THE XR500 SERIES PANEL.

6.2 Earth Ground (GND)

To provide proper transient suppression, XR500 Series panel terminal 4 must be connected to earth ground using 14 gauge or larger wire. DMP recommends connecting to a cold water pipe, ground rod, or building ground only. Do not connect to an electrical ground or conduit, sprinkler or gas pipes, or to a telephone company ground.

6.3 Battery Only Restart

When powering up the XR500 Series panel without AC power, briefly short across the battery start pads to pull in the battery cutoff relay. The leads need a momentary short only. Once the relay has pulled in, the battery voltage holds it in that condition. If the XR500 Series panel is powered up with an AC transformer, the battery cutoff relay is pulled in automatically. For more information refer to Figure 1.

6.4 Battery Replacement Period

DMP recommends replacing the battery every 3 to 5 years under normal use.

6.5 Discharge/Recharge

The XR500 Series battery charging circuit float charges at 13.9 VDC at a maximum current of 1.0 Amps. Listed below are the various battery voltage level conditions:

Battery Trouble:	Below	11.9 VDC
Battery Cutoff:	Below	10.2 VDC
Battery Restored:	Above	12.6 VDC

6.6 Battery Supervision

The XR500 Series tests the battery when AC power is present. The test is done every three minutes and lasts for five seconds. During the test, the panel places a load on the battery; if the battery voltage falls below 11.9 VDC a low battery is detected. If AC power is not present, a low battery is detected any time the battery voltage falls below 11.9 VDC.

If a low battery is detected with AC power present, the test repeats every two minutes until the battery charges above 12.6 VDC indicating the battery has restored voltage. If a weak battery is replaced with a fully charged battery, the restored battery will not be detected until the next two minute test is completed.

6.7 Battery Cutoff

The panel disconnects the battery any time the battery voltage drops below 10.2 VDC. This prevents battery deep discharge damage.

6.8 XR500 Series Canadian Power Requirements

During AC power failure, the XR500 Series panel and all connected auxiliary devices draw their power from the battery. All devices must be taken into consideration when calculating the battery standby capacity. The following table lists the XR500 Series panel power requirements. You must add the additional current draw of keypads, zone expansion modules, smoke detector output, and any other auxiliary devices used in the system for the total current required. The total is then multiplied by the number of standby hours required to calculate the total ampere-hours required.

Standby Battery Power Calculations	Standby Current	Alarm Current
XR500 Series Control Panel	Qty <u> 1 </u> x 180mA <u> 180 </u> mA	Qty <u> 1 </u> x 180mA <u> 180 </u> mA
Relay Outputs 1-2 (ON)	Qty _____ x 30mA _____	Qty _____ x 30mA _____
Switch Grounds 3-6 (ON)	Qty _____ x 5mA _____	Qty _____ x 5mA _____
Active Zones 1-8	Qty _____ x 1.6mA _____	Qty _____ x *2mA _____
Active Zones 9-10	Qty _____ x 4mA _____	Qty _____ x 30mA _____
2-Wire Smoke Detectors	Qty _____ x 0.1mA _____	Qty _____ x 0.1mA _____
Panel Bell Output		1500mA _____ mA
893A Dual Phone Line Module	Qty _____ x 12mA _____	Qty _____ x 50mA _____
461 Interface Adaptor Card		7mA _____
462N Network Interface Card	Qty _____ x 50mA _____	Qty _____ x 50mA _____
462P Printer Interface Card	Qty _____ x 50mA _____	Qty _____ x 50mA _____
463G/CellCom Digital Cellular Communicator	Qty _____ x 21mA _____	Qty _____ x 21mA _____
481 Expansion Interface Card	Qty _____ x 15mA _____	Qty _____ x 15mA _____
1100X Wireless Receiver	Qty _____ x 46mA _____	Qty _____ x 46mA _____
1100XH Wireless High Power Receiver	Qty _____ x 160mA _____	Qty _____ x 160mA _____
860 Relay Output Module (one relay active)	Qty _____ x 34mA _____	Qty _____ x 34mA _____
All four relays active	138mA _____	138mA _____
865 Style Y or Z Notification Module	Qty _____ x 26mA _____	Qty _____ x 85mA _____
866 Style W Notification Module	Qty _____ x 45mA _____	Qty _____ x 76mA _____
867 LX-Bus Style W Notification Module	Qty _____ x 30mA _____	Qty _____ x 86mA _____
869 Dual Style D Initiating Module	Qty _____ x 25mA _____	Qty _____ x 75mA _____
7060/7160 Thinline/7060A Aqualite Keypad	Qty _____ x 72mA _____	Qty _____ x 80mA _____
7063/7163 Thinline/7063A Aqualite Keypad	Qty _____ x 85mA _____	Qty _____ x 100mA _____
7070/7170 Thinline/7070A Aqualite Keypad	Qty _____ x 72mA _____	Qty _____ x 87mA _____
Active Zones (EOL Installed)	1.6mA _____	Qty _____ x *2mA _____
7073/7173 Thinline/7073A Aqualite Keypad	Qty _____ x 85mA _____	Qty _____ x 100mA _____
Active Zones (EOL Installed)	1.6mA _____	Qty _____ x *2mA _____
733 Wiegand Interface Module	Qty _____ x 30mA _____	Qty _____ x 30mA _____
Active Zones (EOL Installed)	Qty _____ x 1.6mA _____	Qty _____ x *2mA _____
Annunciator (ON)		Qty _____ x 20mA _____
734 Wiegand Interface Module	Qty _____ x 15mA _____	Qty _____ x 15mA _____
Active Zones (EOL Installed)	Qty _____ x 1.6mA _____	Qty _____ x *2mA _____
Annunciator (ON)		Qty _____ x 20mA _____
734N Wiegand Interface Module	Qty _____ x 146mA _____	Qty _____ x 148mA _____
Active Zones (EOL Installed)	Qty _____ x 1.6mA _____	Qty _____ x *2mA _____
Annunciator (ON)		Qty _____ x 20mA _____
Wiegand Reader	Qty _____ x 200mA _____	Qty _____ x 200mA _____
734N-WiFi Wiegand Interface Module	Qty _____ x 146mA _____	Qty _____ x 148mA _____
Active Zones (EOL Installed)	Qty _____ x 1.6mA _____	Qty _____ x *2mA _____
Annunciator (ON)		Qty _____ x 20mA _____
Wiegand Reader	Qty _____ x 200mA _____	Qty _____ x 200mA _____
Copy Sub-Totals to next page	Sub-Total Standby _____ mA	Sub-Total Alarm _____ mA
*Based on 10% of active zones in alarm.		

INSTALLATION

Standby Battery Power Calculations	Standby Current	Alarm Current
736P POPIT Interface Module Radionics Popex, POPITs, OctoPOPITs	Qty _____ x 25mA _____ Qty _____ x _____mA _____	Qty _____ x 25mA _____ Qty _____ x _____mA _____
738A Ademco Wireless Interface Module	Qty _____ x 75mA _____	Qty _____ x 75mA _____
710 Bus Splitter/Repeater Module	Qty _____ x 32mA _____	Qty _____ x 32mA _____
711 Zone Expansion Module Active Zone (EOL Installed)	Qty _____ x 11mA _____ Qty _____ x 1.6mA _____	Qty _____ x 11mA _____ Qty _____ x *2mA _____
714 Zone Expansion Module Active Zones (EOL Installed)	Qty _____ x 7mA _____ Qty _____ x 1.6mA _____	Qty _____ x 7mA _____ Qty _____ x *2mA _____
712-8 Zone Expansion Module Active Zones (EOL Installed)	Qty _____ x 17mA _____ Qty _____ x 1.6mA _____	Qty _____ x 17mA _____ Qty _____ x *2mA _____
714-8, 714-16 Zone Expansion Module Active Zones (EOL Installed)	Qty _____ x 20mA _____ Qty _____ x 1.6mA _____	Qty _____ x 20mA _____ Qty _____ x *2mA _____
715 Zone Expansion Module Active Zones (EOL Installed) 2-Wire Smokes	Qty _____ x 7mA _____ Qty _____ x 4mA _____ Qty _____ x .1mA _____	Qty _____ x 7mA _____ Qty _____ x *30mA _____ Qty _____ x .1mA _____
715-8, 715-16 Zone Expansion Modules Active Zones (EOL Installed) 2-Wire Smokes	Qty _____ x 20mA _____ Qty _____ x 4mA _____ Qty _____ x .1mA _____	Qty _____ x 20mA _____ Qty _____ x *30mA _____ Qty _____ x .1mA _____
716 Output Expansion Module Active Form C Relays	Qty _____ x 13mA _____	Qty _____ x 13mA _____ Qty _____ x 12mA _____
717 Graphic Annunciator Module Annunciator Outputs	Qty _____ x 10mA _____	Qty _____ x 10mA _____ Qty _____ x 1mA _____
521LX, 521LXT Smoke Detectors	Qty _____ x 8.8mA _____	Qty _____ x *28mA _____
572 Indicator LED	Qty _____ x 20mA _____	Qty _____ x 20mA _____
Aux. Powered Devices on Terminals 7 and 11 Other than Keypads and LX-Bus Modules	_____ mA	_____ mA
This page only	Sub-Total Standby _____ mA	Sub-Total Alarm _____ mA
Sub-Totals from previous page	Sub-Total Standby _____ mA	Sub-Total Alarm _____ mA
*Based on 10% of active zones in alarm	Total Standby _____ mA	Total Alarm _____ mA
<p>Total Standby _____ mA x number of Standby Hours needed _____ = _____ mA-hours</p> <p>Total Alarm _____ mA + _____ mA-hours</p> <p>Total _____ mA-hours</p> <p>X .001</p> <p>= _____ Amp-hrs Required</p>		

Refer to section 6.9 for standby battery selection.

6.9 Standby Battery Selection

To choose the type and number of batteries needed for 24, 60, or 72 hours of standby power based on the Amp Hours Required calculation from section 6.8 XR500 Series Power Requirements, perform the following:

1. Select the desired standby hours required from the table below: 24, 60, or 72 hours
2. Select the desired battery size: Model 368 (12 VDC 4.5 Ah), Model 369 (12 VDC 7 Ah), Model 367 (12 VDC 7.7 Ah), Model 365 (12 VDC 9 Ah), Model 366 (12 VDC 18 Ah).
3. Select a Max. Ah Available number that is just greater than the number calculated in Amp Hours Required.
4. Install the number of batteries shown in the corresponding No. of Batteries required column.

Example: If the Amp Hours Required calculation equals 22 Ah for 24 hours of standby time and 4.5 Ah batteries are desired, install six (6) Model 368 (12 VDC, 4.5 Ah) batteries.

Note: You can use either a Model 327-CAN Plug-in 50 VA or ATC Frost FTA7516 75VA Transformer with any of the Number of Batteries choices listed below.

24 hours of standby power

4.5 Ah Batteries		7 Ah Batteries		7.7 Ah Batteries		9 Ah Batteries		18 Ah Batteries	
Max. Ah Available	No. of Batteries	Max. Ah Available	No. of Batteries	Max. Ah Available	No. of Batteries	Max. Ah Available	No. of Batteries	Max. Ah Available	No. of Batteries
8	2	6	1	6	1	8	1	16	1
12	3	12	2	13	2	16	2	32	2
16	4	18	3	20	3	24	3	48	3
20	5	24	4	27	4	32	4		
24	6	31	5	34	5	40	5		
28	7	37	6	41	6				
32	8	43	7						
36	9								
40	10								

Note: 48 hours is the typical battery recharge time for any of the Number of Batteries shown in this section.

60 hours of standby power

7 Ah Batteries		7.7 Ah Batteries		9 Ah Batteries		18 Ah Batteries	
Max. Ah Available	No. of Batteries	Max. Ah Available	No. of Batteries	Max. Ah Available	No. of Batteries	Max. Ah Available	No. of Batteries
13	2	14	2	17	2	17	1
20	3	22	3	26	3	34	2
27	4	29	4	34	4	52	3
33	5	37	5	43	5	69	4
40	6	44	6	52	6		
47	7	52	7	61	7		
54	8	59	8	69	8		
60	9	67	9				
67	10						

Note: 48 hours is the typical battery recharge time for any of the Number of Batteries shown in this section.

72 hours of standby power

9 Ah Batteries		18 Ah Batteries	
Max. Ah Available	No. of Batteries	Max. Ah Available	No. of Batteries
16	2	16	1
25	3	33	2
33	4	50	3
42	5	67	4
50	6		
59	7		
67	8		

Note: 72 hours is the typical battery recharge time required for any of the Number of Batteries shown in this section.

Note: If the Amp Hours Required calculation is greater than any Max. Ah Available number shown on a table, then add power supply(s) to power some system devices allowing the Amp Hours Required calculation to be reduced. See the 710 Bus Splitter/Repeater Installation Guide (LT-0310).

Bell Output

7.1 Terminals 5 and 6

Terminal 5 supplies positive 12 VDC to power alarm bells or horns. This output can be steady, pulsed, or temporal depending upon the Bell Action specified in Bell Options. Terminal 6 is the ground reference for the bell circuit. This supervised output detects 1k Ohms or less as normal. The indicating appliance can supply this resistance. If using a horn or siren, a 1k Ohm 1/2 W EOL resistor (provided) should be added across the bell circuit to provide supervision. See the Notification Appliance section for a list of approved notification appliances and the Wiring Diagrams for connections.

Keypad Bus

8.1 Description

XR500 Series panel terminals 7, 8, 9, and 10 are for the keypad bus. You can connect up to sixteen supervised keypads and multiple unsupervised keypads to the XR500 Series. In addition to DMP LCD keypads, you can also connect any combination of zone expansion modules to the data bus. Refer to the specific device installation sheet for the maximum number of Keypad Bus devices.

Refer to the section titled LX-Bus for complete information about the LX-Bus 4-pin header and expansion slot.

Note: Do not use shielded wire for LX-Bus/Keypad Bus circuits.

8.2 Terminal 7 - RED

This terminal supplies positive 12 VDC Regulated to power DMP LCD keypads and zone expansion modules. Terminal 7 also supplies power for any auxiliary device. The ground reference for terminal 7 is terminal 10.

The output current is shared with the smoke power output on terminal 11 and Zones 9 and 10. Current draw for all connected devices must not exceed the panel maximum current rating. See Power Supply in the Compliance section for maximum current in a fire listed application.

8.3 Terminal 8 - YELLOW

Terminal 8 receives data from keypads and zone expansion modules. It cannot be used for any other purpose.

8.4 Terminal 9 - GREEN

Terminal 9 transmits data to keypads and zone expansion modules. It cannot be used for any other purpose.

8.5 Terminal 10 - BLACK

Terminal 10 is the ground reference for DMP LCD keypads, zone expansion modules, and all auxiliary devices being powered by terminal 7.

8.6 J8 Programming Connection

A 4-pin header (J8) is provided to connect a keypad when using a DMP Model 330 Programming Cable. This provides a quick and easy connection for panel programming.

You may also use the J8 Programming Header to connect Keypad Bus devices. This is an alternative to connecting keypad bus devices to terminals 7, 8, 9, and 10.

8.7 OVC LED

The Overcurrent LED (OVC) lights Red when the devices connected to the Keypad Bus and LX-Bus(es) draw more current than the panel rating. The OVC is located above Outputs 1 and 2 on the panel and turns a steady Red when lit. When the OVC LED lights Red, the LX-Bus(es) and Keypad bus are shut down.

Smoke and Glassbreak Detector Output

9.1 Terminals 11 and 12

Terminal 11 supplies positive 12 VDC Regulated to power 4-wire smoke detectors and other powered devices. This output can be turned off by the user for 5 seconds using the Sensor Reset User Menu option to allow latched devices to reset. Terminal 12 is the ground reference for terminal 11.

9.2 Current Rating

The Output current from terminal 11 is shared with terminals 7, 25, and 27.



The total current draw of all devices powered from the panel must be included with terminal 11 calculations and must not exceed the maximum output rating.

Protection Zones

10.1 Terminals 13–24

Zones 1 to 8 (terminals 13 to 24) on the XR500 Series panel are all grounded burglary zones. For programming purposes, the zone numbers are 1 through 8. Listed below are terminal 13 to 24 connection functions.

Terminal	Function	Terminal	Function
13	Zone 1 voltage sensing	19	Zone 5 voltage sensing
14	Ground for Zones 1 and 2	20	Ground for Zones 5 and 6
15	Zone 2 voltage sensing	21	Zone 6 voltage sensing
16	Zone 3 voltage sensing	22	Zone 7 voltage sensing
17	Ground for Zones 3 and 4	23	Ground for Zones 7 and 8
18	Zone 4 voltage sensing	24	Zone 8 voltage sensing

The voltage sensing terminal measures the voltage across a 1k Ohm End-of-Line resistor to ground. Use DMP Model 311 1k Ohm resistors. Dry contact sensing devices can be used in series (normally-closed) or in parallel (normally-open) with any of the burglary protection zones.

Each protection zone detects three conditions: Open, Normal, and Short. Listed below are voltage and resistance parameters for each condition:

Condition	Resistance on zone	Voltage on positive terminal
Open	over 1300 ohms	over 2.0 VDC
Normal	600 to 1300 ohms	1.2 to 2.0 VDC
Short	under 600 ohms	under 1.2 VDC

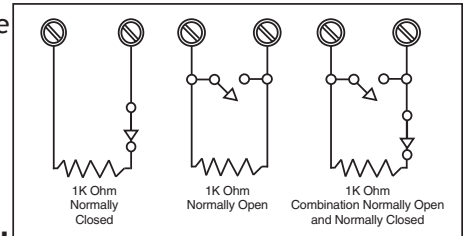

Figure 7: Protection Zone Wiring

10.2 Dual EOL

The XR500 Series Canadian panel supports the use of dual 1K EOL resistors on panel zones one to eight. Two EOL resistors are used so a wire trouble can be indicated during the disarm period. When dual end-of-line operation is chosen in panel programming, normal zone processing occurs with the following exception: When processing an open zone and a trouble or alarm message is NOT programmed to be sent for the open state, the panel checks to see if the wire is cut. If the wire is cut, the panel automatically sends an alarm if armed or trouble is disarmed.

ZONE STATUS

	Zone Wires Open	Zone Wires Short	Contact Normal	Contact Open
Disarmed	Trouble	Trouble	Normal	Normal
Armed	Alarm	Alarm	Normal	Alarm

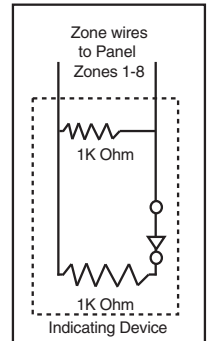

10.3 Zone Response Time

A condition must be present on a zone for 500 milliseconds before it is detected by the XR500 Series panel. Ensure detection devices used on the protection zones are rated for use with this delay. Zones 1-10 can also be programmed for a fast response delay of 160 milliseconds.

10.4 Keyswitch Arming Zone

A keyswitch on an Arming type zone allows selected areas to arm and disarm without having to enter a user code.

Powered Zones for 2-Wire Smoke Detectors

11.1 Terminals 25–26 and 27–28

Panel terminals 25 through 28 provide two resettable Class B, Style A, 2-wire powered zones. For programming purposes the zone numbers are 9 and 10.

Note: The maximum wire length for either zone 9 or zone 10 is 3000 feet using 18 AWG or 1000 feet using 22 AWG. The maximum voltage is 14 VDC and the maximum normal standby current is 1.25mA DC. The maximum line impedance is 100 Ohms. The maximum short circuit current is 56mA.

When using 725 Zone Expansion Modules, use listed Model 316 EOL resistors. The compatibility identifier for the zones using 725 Zone Expansion Modules is B. When using all other zone expansion modules, use listed Model 309 EOL resistors. The compatibility identifier for the zones is A.

Note: Do not mix detectors from different manufacturers on the same zone.



Caution: Performing a Sensor Reset momentarily drops power to the devices on Zones 9 and 10. The panel views these zones (9 and 10) as “Open” while the power is absent.

INSTALLATION

11.2 Compatible 2-Wire Smoke Detector Chart

Manufacturer	Model	Detector ID	Base	Base ID	DC Voltage Range	# of Detectors (12V/24V)	Zone Expansion Modules	Panel Zones
Detection Systems	DS230, DS230F	B/A	MB2W, MB2WL	A	8.5-33	10	725	
Detection Systems	DS250, DS250TH	B	MB2W, MB2WL	A	8.5-33	10/12	715, 715-8, 715-16, 725	9 & 10
Detection Systems	DS250HD	B	MB2W, MB2WL	A	8.5-33	10	715, 715-8, 715-16	9 & 10
Detection Systems	DS260	B/A	MB2W, MB2WL	A	8.5-33	17	725	
Detection Systems	DS282, DS282TH, DS282THC, DS282THS	B			8.5-33	10/12	715, 715-8, 715-16, 725	9 & 10
Hochiki	SLR-835B-2 SLR-835BH-2	HD-6	N/A		8-35	14	725	
Hochiki	SLR-24, SLR-24H	HD-3	NS4-220	HB-3	15-33	15	725	
Hochiki	SIJ-24, DCD-190, DCD-135	HD-3	NS4-220	HB-3	15-33	15	725	
Hochiki	SLR-24, SLR-24H	HD-3	NS6-220	HB-3	15-33	15	725	
Hochiki	SIJ-24	HD-3	NS6-220	HB-3	15-33	20	725	
Hochiki	DCD-190, DCD-135	HD-3	NS6-220	HB-3	15-33	16	725	
Sentrol/ESL	429AT, 521B, 521BXT, 521NB, 521NBXT	S09A			6.5-20	12	715, 715-8, 715-16	9 & 10
Sentrol/ESL	429C, 429CT, 521B/BXT	S10A			8.5-33	12	725	
Sentrol/ESL	429CRT, 429CST, 429CSST, 521CRXT	S11A			8.5-33	12	725	
Sentrol/ESL	711U, 712U, 713-5U, 713-6U, 721U, 721UT	S10A	701E, 70-1U, 702E, 702U	S00	8.5-33	12	725	
Sentrol/ESL	731U, 723U	S11A	701E, 701U, 702E, 702U, 702RE, 702RU	S00	8.5-33	12	725	
System Sensor	1400	A			8.5-35	10	715, 715-8, 715-16	9 & 10
System Sensor	1151, 2151	A	B110PL, B401		8.5-35	10/10	715, 715-8, 715-16, 725	9 & 10
System Sensor	1451, 2451TH	A	B401, B401B		8.5-35	10	715, 715-8, 715-16	9 & 10
System Sensor	1451DH	A	DH400		8.5-35	10	715, 715-8, 715-16	9 & 10
System Sensor	2100T, 2100B, 2100TB, 2100D, 2100TD	A			8.5-35	10	715, 715-8, 715-16	9 & 10
System Sensor	2400, 2400AT, 2400AIT, 2400TH	A			8.5-35	10	715, 715-8, 715-16	9 & 10
System Sensor	2451	A	B401, B401B, DH400		8.5-35	10	715, 715-8, 715-16	9 & 10
System Sensor	2W-B, 2WT-B	A			8.5-35	10	715, 715-8, 715-16	9 & 10
System Sensor	2WTA-B, 2WTR-B	A			8.5-35	10	715, 715-8, 715-16	9 & 10
System Sensor	DH100P, DH100LP	A			8.5-35	10	715, 715-8, 715-16, 725	9 & 10

Figure 7: Compatible 2-Wire Smoke Detectors

Dry Contact Relay Outputs

12.1 Description

The XR500 Series panel provides two programmable auxiliary SPDT relays when equipped with two DMP Model 305 relays in sockets K6 (Output 1) and K7 (Output 2) and a Model 431 Output Harness on the J2 6-pin Header. Each relay provides one SPDT set of contacts that can be operated by any of the functions listed below:

- | | |
|---|--------------------------|
| 1) Activation by zone condition: Steady, Pulsing, Momentary, and Follow | |
| 2) Activation by 24-hour 7-day schedule: One on and one off time a day for each relay | |
| 3) Manual activation from the DMP LCD keypad menu | |
| 4) Communication failure | 8) Exit and Entry timers |
| 5) Armed area annunciation | 9) System Ready |
| 6) Fire Alarm, Fire Trouble or Supervisory | 10) Late to Close |
| 7) Ambush Alarm | |

Refer to the XR500 Series Canadian Programming Guide (LT-0679CAN) for specific information.

12.2 Contact Rating

The Model 305 relay contacts are rated for 1 Amp at 30 VDC (allows .35 power factor). You can connect auxiliary power to the Relay Output 1 common terminal by installing the gray harness wire to terminal 7. Current draw for all connected devices must not exceed the panel maximum current rating.

12.3 Model 431 Output Harness Wiring

The relay contacts are accessible by installing the DMP 431 Output Harness on the 6-pin header labeled J2. Output 2 uses the top three prongs, and Output 1 uses the bottom three prongs. The wire harness and contact locations are shown below:

Contact	Color
Output 1 normally closed	Violet
Output 1 common	Gray
Output 1 normally open	Orange
Output 2 normally closed	Violet with white stripe
Output 2 common	White with gray stripe
Output 2 normally open	Orange with white stripe

The relay contacts must be connected to devices located within the same room as the XR500 Series panel.

Annunciator Outputs

13.1 Description

The four programmable annunciator outputs can be programmed to indicate the activity of the panel zones or conditions occurring on the system. Annunciator **outputs do not provide a voltage but instead switch-to-ground** a voltage from another source. The outputs can respond to any of the conditions listed in the Description section for Dry Contact Relays. Maximum voltage is 30 VDC @ 50mA.

13.2 Model 300 Harness Wiring

Access the open collector outputs by installing DMP 300 Harness on the 4-pin header labeled J11. The output locations are shown below. For listed applications, devices connected to the outputs must be located within the same room as the panel.

Output	Color	Wire	Output	Color	Wire
3	Red	1	5	Green	3
4	Yellow	2	6	Black	4

13.3 Model 860 Relay Module

Connect a Model 860 Relay Module to the J11 on the XR500 Series Canadian panel to provide relays for outputs 3-6. Use these relays for electrical isolation between the alarm panel and other systems or for switching voltage to control various functions. Power is supplied to the relay coils from a single wire connected to the panel auxiliary power terminal 7. The module includes one relay and provides three additional sockets for expansion of up to four relays. Mount the 860 inside the panel enclosure using the 3-hole pattern and plastic standoffs. Refer to the 860 Module Install Sheet (LT-0484) as needed.

Relay Contact Rating: 1 Amp at 30 VDC (allows .35 power factor)

J23 6-Pin Header

14.1 Description

The XR500 Series Canadian Command Processor™ panel supports RS-232, LX-Bus, and DMP Wireless operation. Only one operation can function at a time. Install a jumper on one pair of J23 headers to indicate how the panel is programmed to operate. Refer to the table below when installing a jumper on J23. When a jumper is installed or moved on the 6-pin header, briefly reset the panel using the J16 jumper to activate the selected operation.

Note: Only one operation, RS-232, LX-Bus, or DMP Wireless can function at a time.

J23 6-Pin Header	
Letter	Operation
R	Standard RS-232
L	LX-Bus
X	1100 Series DMP Wireless

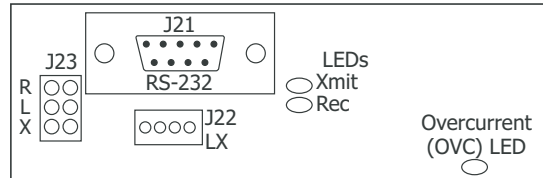

Figure 8: J23 6-Pin Header

J22 LX-Bus Expansion Connector

15.1 Description

The XR500 Series Canadian Command Processor™ Panel supports up to 500 wireless bus zones or up to five LX-Bus circuits. Each Interface card LX-Bus circuit provides 100 expansion zones. The maximum number of LX-Bus zones available on a fully populated panel is 500. Use LX-Bus J22 Header for 100 zones. Install a single Interface Card Connector on the board to support 100 additional zones for a total of 200 zones. To install up to five Interface Cards install a Model 461 Interface Adaptor Card.

15.2 J22 LX-Bus Header

Note: Only one connector, J21 or J22 can function at a time. Either use J21 to connect a serial device for PC Log Reporting, or use J22 to connect an LX-Bus or DMP Wireless device. Operation is determined by where you install the jumper on the J23 6-Pin header. See the Connecting LX-Bus and Keypad Bus Devices section for maximum wiring distances.

For each connection, respect wire colors when connecting devices and use all four wires. After placing the jumper on the J23 6-Pin header to enable the required operation, briefly reset the panel using the J16 jumper to activate operation.

Wireless Bus Operation: Place a jumper on the two pins next to the letter “X” on the J23 6-Pin header. When using J22 as a wireless bus, connect a DMP Model 300 4-wire Harness to the J22 4-pin header labeled LX. Connect the other end to the J3 header on the 1100X or 1100XH Wireless Receiver. This provides up to 500 wireless zones numbered 500 to 999. Refer to the 1100X Wireless Receiver Install Guide (LT-0708) or the 1100XH Wireless Receiver Install Guide (LT-0970).

LX-Bus Operation: Place a jumper on the two pins next to the letter “L” on the J23 6-Pin header. When using J22 as an LX-Bus, connect a DMP Model 300 4-wire Harness to the J22 4-pin header labeled LX. This provides the first 100 LX-Bus zones numbered 500-599. No LX-Bus Interface Card is required.

Note: Do NOT use shielded wire when using the J22 LX-Bus Header.

RS-232 Operation: Place a jumper on the two pins next to the letter “R” on the J23 6-Pin header and refer to J21 Serial Connector.

15.3 LX-Bus Interface Cards

You can add one Interface Card (Model 481, 462N, 462P, or 463G) to the XR500 Series using J6 Interface Card Connector located on the board right edge. To add more than one Interface Card install a 461 Interface Adaptor Card using J6 Interface Card Connector on the board right edge. The 461 Adaptor Card allows up to five Interface Cards to be installed. Refer to the 461 Installation Sheet (LT-0736). Each Interface card provides up to 100 LX-Bus Zones. Refer to the following tables to identify zone locations and numbers relative to J22 operation.

J22 LX-Bus Enabled (Set J23 to "L")		AND	One Interface Card		OR	461 Adaptor Card and Multiple Interface Cards	
LX-Bus	Zone Numbers		LX-Bus	Zone Numbers		LX-Bus	Zone Numbers
1	500-599		2	600-699		2 (A)	600-699
						3 (B)	700-799
						4 (C)	800-899
						5 (D)	900-999

J22 LX-Bus NOT Enabled (J23 NOT set to "L")	One Interface Card		OR	461 Adaptor Card and Multiple Interface Cards	
	LX-Bus	Zone Numbers		LX-Bus	Zone Numbers
	1	500-599		1 (A)	500-599
				2 (B)	600-699
				3 (C)	700-799
				4 (D)	800-899
				5 (E)	900-999

15.4 LX-Bus LEDs

The two LEDs, located near the bottom-right corner of J21 indicate data transmission and receipt. The top LED flashes green to indicate the panel is transmitting LX-Bus data. The bottom LED flashes yellow to indicate the panel is receiving LX-Bus data.

15.5 OVC LED

The Overcurrent LED (OVC) lights Red when the devices connected to the Keypad Bus and LX-Bus(es) draw more current than the panel rating. The OVC is located above Outputs 1 and 2 on the panel and turns a steady Red when lit. When the OVC LED lights Red, the LX-Bus(es) and Keypad bus shut down.

J21 Serial Connector

16.1 Description

Note: Only one connector, J21 or J22 can function at a time. Either use J21 to connect a serial device for PC Log Reporting, or use J22 to connect a DMP Wireless device or an LX-Bus device. Operation is determined by where you install the jumper on the J23 6-Pin header. The maximum line impedance is 100 Ohms.

To enable J21 to operate in RS-232 mode, place a jumper on the two pins next to the letter "R" on the J23 6-Pin header and briefly reset the panel using the J16 jumper to activate the selected operation. Panel programming using Remote Link™ can be set up through a direct connection to a computer. The Serial Connector allows the following operation options.

XR500 Panel	XR500N/XR500E Panel
PC Log Reports	PC Log Reports
Remote Link™ Programming	

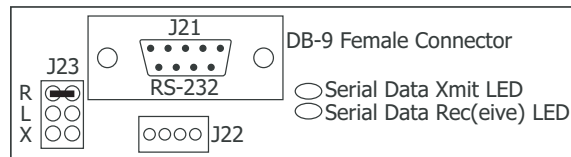

Figure 9: J21 Serial Connection

16.2 Computer Connection to J21

Use a straight through RS-232 Serial cable with a DB-9 female connector on one end and a DB-9 male connector on the other end. Plug the DB-9 male connector end of the cable onto the XR500 Series panel J21 RS-232 connector. Plug the DB-9 female connector end of the cable onto the DB-9 male connector located at the back of the computer. Program the XR500 Series panel as needed then disconnect the computer.

16.3 Serial Connector LEDs

The two LEDs, located near the bottom-right corner of J21 indicate data transmission and receipt. The top LED flashes green to indicate the panel is transmitting serial data. The bottom LED flashes yellow to indicate the panel is receiving serial data.

J1 Ethernet Connector (XR500N/XR500E only)

17.1 Description

The J1 Ethernet Connector is available on the XR500N/XR500E Network version to connect directly to an Ethernet network using a standard patch cable. The maximum impedance is 100 Ohms.

17.2 Ethernet LEDs

The two LEDs, located to the left of J1 Ethernet Connector, indicate network connection. The top, Link LED lights up green to indicate a valid receive connection from the host network. The bottom, Activity LED flashes yellow to indicate messages are being sent and received.

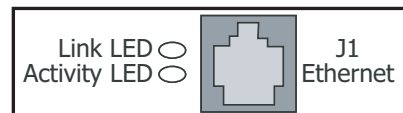

Figure 10: J1 Header and LEDs

J3 Telephone RJ Connector

18.1 Description

Connect the panel to the public telephone network by installing a DMP 356 RJ Cable between the panel J3 connector and the RJ31X or RJ38X phone block. The maximum impedance is 100 Ohms. **CAUTION** - To reduce the risk of fire, use only No. 26 AWG or larger telecommunication line cord, such as DMP Model 356 Series Phone Cords.

18.2 J10 893A Connector

Connect an 893A Dual Phone Line Module to J10 on the XR500 Series. Refer to the 893A Installation Sheet (LT-0135) for complete information.

18.3 Notification

The user must not repair registered terminal equipment. In case of trouble, immediately unplug the device from the telephone jack. The factory warranty provides for repairs. Registered terminal equipment may not be used on party lines or in connection with coin telephones. Notify the telephone company with the following information:

- a. The particular line(s) where the service is connected
- b. This Class A digital apparatus complies with Canadian ICES-003.
- c. The ringer equivalence
- d. The device make, model, and serial number

18.4 Phone Line Monitor

The XR500 Series panel has a built-in telephone monitor that monitors the phone line voltage to verify the connection to the central office. Figure 11 and the table below identify the phone block pin layout, wire numbers, and colors.

Wire Number	Wire Color
1	Gray
2	Orange
3	Black
4	Red
5	Green
6	Yellow
7	Blue
8	Brown

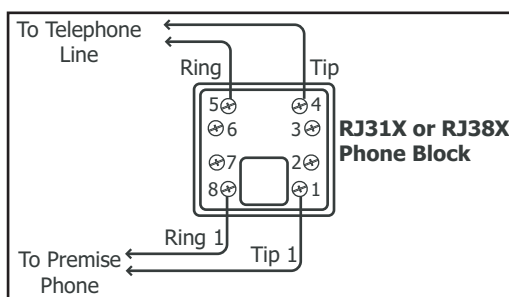

Figure 11: Phone Jack Wiring

The wires on the RJ31 that feed pins 4 and 5 should be the ONLY wires on the D-marc. All other house phone wiring should be tied to pins 1 and 8 coming back from the RJ31.

Dial tone must come into RJ31X on pins 4 and 5 and go back to house phones from pins 1 and 8. Follow these steps to determine if panel is seizing the line:

1. Unplug phone cord from RJ31X
2. Place butt-set on pins 4 and 5
3. Listen for dial tone. With dial tone present, lift either wire from pins 1 or 8
4. Listen for dial tone again. If the dial tone is present, RJ31X wiring is correct. If no dial tone is present, the RJ31X wiring is backwards. Rewire so dial tone is coming IN on 4 and 5.

If you still have trouble with the phone line, you may need to replace the RJ cord. If the dial tone is still not present, swap out the RJ31X phone block.

Reset and Tamper Headers

19.1 J16 Reset Header

The reset header is located just above the terminal strip on the right side of the circuit board and is used to reset the XR500 Series microprocessor. To reset the panel when first installing the system, install the reset jumper before applying power to the panel. After connecting the AC and battery, remove the reset jumper.

To reset the panel while the system is operational, for example, prior to reprogramming, install the reset jumper without powering down the system. Remove the reset jumper after one or two seconds.

After resetting the panel, begin programming within 30 minutes. If you wait longer than 30 minutes, you must reset the panel again.

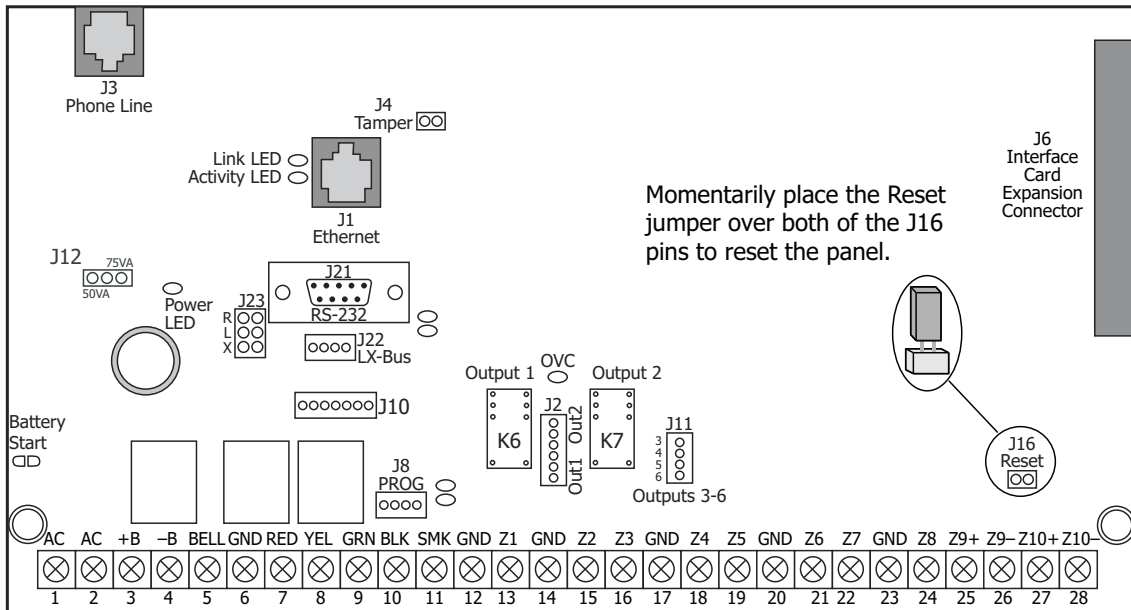

Figure 12: XR500 Series Canadian Panel Showing the Reset Jumper

19.2 J4 Tamper Header

The J4 header is for use with the optional DMP 306 Tamper Harness. The harness connects to one or more tamper switches mounted inside the panel enclosure to supervise against unauthorized enclosure opening or removal. Refer to the wiring diagram on the enclosure door for correct tamper switch wiring.

How the Tamper Works

If the enclosure is opened or removed while one or more of the system areas are armed, a panel tamper alarm is indicated. If all areas are disarmed, a panel tamper trouble is indicated.

Listed Compliance Specifications

20.1 Introduction

For applications that must conform to a local authorities installation standard or a National Recognized Testing Laboratory certificated system, please see the following sections.

Burglary Specifications

21.1 Introduction

The programming and installation specifications contained in this section must be completed when installing the XR500 Series Canadian panel in accordance with any of the burglary standards. Additional specifications may be required by a particular standard. See the XR500 Series Canadian Programming Guide (LT-0679CAN).

21.2 Control Outside of Protected Area

A Potter EVD or Sentrol 5402 must be used when the panel is installed outside of the vault in a financial application. Front and rear tamper switches are required. Refer to the system wiring diagram.

21.3 Bypass Reports

The Bypass Reports option must be programmed as YES for all listed burglary applications.

21.4 System Maintenance

To ensure continuous satisfactory operation of any alarm system, proper installation and regular maintenance by the installing alarm company and frequent testing by the end user is essential. Offering a maintenance program and acquainting the user with the correct procedures for system use and testing is also the responsibility of the installing alarm company.

ULC S304-06 Specifications

Signal Receiving Center and Premise Burglar Alarm Control Units

22.1 For Medium or High Risk Applications: Level A3 Communication

Level A3 communication channel security is provided for Internet, Intranet, LAN or WAN networks when configured as a NET or CELL communicating system using the XR500E. The following options must be programmed in XR500E Canadian panel Communication:

NET PRIMARY	
SUB CODE:	YES
CHECKIN TIME:	2 MINUTES
FAIL TIME:	3 MINUTES
SEND COMM TRBL:	YES
TCP COMM:	YES
ENCRYPTION:	ENABLED

CELL PRIMARY:	
SUB CODE:	YES
CHECKIN TIME:	3 MINUTES
FAIL TIME:	3 MINUTES
SEND COMM TRBL:	YES
ENCRYPTION:	ENABLED

22.2 For Very High Risk Applications: Level A3 Plus P1 Communication

Additionally, XR500E communicating system may use two channels (NET plus Dialer, CELL plus Dialer, or NET plus CELL) to send signals simultaneously. The following options must be programmed in XR500E Canadian panel Communication:

NET PRIMARY		DIALER PRIMARY:
SUB CODE:	YES	USE DAILY TEST
CHECKIN TIME:	2 MINUTES	
FAIL TIME:	3 MINUTES	
SEND COMM TRBL:	YES	
TCP COMM:	YES	
ENCRYPTION:	ENABLED	

CELL PRIMARY		DIALER PRIMARY:
SUB CODE:	YES	USE DAILY TEST
CHECKIN TIME:	3 MINUTES	
FAIL TIME:	3 MINUTES	
SEND COMM TRBL:	YES	
ENCRYPTION:	ENABLED	

NET PRIMARY		CELL PRIMARY:
SUB CODE:	YES	YES
CHECKIN TIME:	2 MINUTES or less	24 HOURS or less
FAIL TIME:	3 MINUTES or less	
SEND COMM TRBL:	YES	
TCP COMM:	YES	
ENCRYPTION:	ENABLED	

In addition, the SCS-101 Network Line Card installed in the SCS-1R Receiver must have the ACK Substitution Message programmed as NO.

22.3 For Low Risk Applications: Level A1

Level A1 communication channel security is provided for Internet, Intranet, LAN or WAN networks when configured as a NET communicating system using the XR500N.

22.4 For Low Risk Applications: Level P1

Level P1 communication channel security is provided when configured as a DD communicating system and a daily test message using the XR500.

22.5 Dual Protection

For Medium or High Risk ULC Listed Applications: Use only zones 1-8 on the control panel and program Dual EOL as Yes in panel programming. Program the Disarmed Short Message in Alarm Action of Zone Information programming as a Trouble message.

If using a 714, 714-8, or 714-16 for dual protection, program two zones as the same name or equivalent and connect to the contact in the protected area as show in the Dual Zone Protection diagram in the back of this guide.

22.6 Remote Arming

For ULC Listed applications, remote arming is not permitted.

22.7 Zone Expansion

Use of the following zone expanders are permitted for connection of burglary devices:

710 Bus Splitter Module	714 Zone Expander, 4 zones	715 Zone Expander, 4 zones	7070(A)/7073(A) Keypads, 4 zones
711 Zone Expander, Single	714-8 Zone Expander, 8 zones	715-8 Zone Expander, 8 zones	7170/7173 Keypads, 4 zones
712-8 Zone Expander, 8	714-16 Zone Expander, 16 zones	715-16 Zone Expander, 16 zones	

ULC S559-04 Specifications

Equipment for Fire Signal Receiving Centers and Systems

23.1 For Fire Communicator Applications

For fire communicator applications, communication to the fire signal receiving center is provided for Internet, Intranet, LAN or WAN networks when configured as a NET or CELL communicating system using the XR500 Series panel. See wiring diagram in section 25.6 for additional information. Program one of the following options in panel Communication:

Path 1 Type NET or CELL Primary with no Backup

Path 1 Programming	
Comm Type = NET or CELL	Checkin Min = 3
Path Type = Primary	Failtime Min = 3
Sub Code = No	Send Comm Trbl = Yes
Comm Path Trbl = Yes (Status List Programming)	

Path 1 Type NET Primary and Path 2 Type CELL Backup

Path 1 Programming	Path 2 Programming
Comm Type = NET	Comm Type = CELL
Path Type = Primary	Path Type = Backup
Test Rpt = Yes	Test Rpt = Yes
Test Freq = 1 Dy	Test Freq = 1 Dy
Send Comm Trbl = Yes	Send Comm Trbl = Yes
Comm Path Trbl = Yes (Status List Programming)	

23.2 Central Station Host Automation

The fire signal receiving center’s host automation system must recognize the following signals: Zone 1 Alarm = Fire Alarm, Zone 2 Trouble = Fire Zone Trouble, Zone 3 Trouble = AC Trouble, Zone 4 Trouble = Battery Trouble, and Zone 5 Trouble = Ground Fault Trouble.

Recommendations

24.1 ULC Burglary Installation Recommendations

1. In order to give the digital alarm communicator transmitter the ability to disconnect an incoming call to the protected premises, telephone service should be of the type that provides for timed release disconnect.
2. Network access and domain access policies shall be set to restrict unauthorized network access and “spoofing” or “denial of service” attacks.
3. Select Internet Service Providers that have redundant servers/systems, Back-up power, Routers with Firewall enabled and Methods to identify and protect against “Denial of Service” attacks (i.e. via “spoofing”).
4. Power for network equipment as hubs, switches, routers, servers, modems, etc., shall be backed up or powered by an un-interruptable power supply (UPS), stand-by battery or the control unit, capable of facilitating 24 hour standby, compliant with Clauses 16.1.2 and 16.4.1 of CAN/ULC-S304-06.
5. Where such cannot be facilitated, the control unit shall support back-up communications for a secondary communications path, subject to the following:
 - Low Risk and Medium Risk shall use a dialer as a minimum;
 - High Risk shall use cellular control channel or long range radio as a minimum; and
 - Very High Risk shall be equipped with 24 hour standby power. Note: Refer to Table 11 of CAN/ULC-S304-06 for the risk levels.
6. Refer to CAN/ULC-S302, Installation and Classification of Burglar Alarm Systems for Financial and Commercial Premises, Safes and Vaults, for requirements for a secondary communications path, where 24 hour standby cannot be facilitated for all communications interface components as routers, hubs, switches and other network components.
7. Products or components of products used in communication channels, which perform communications functions only, shall comply with the requirements applicable to communications equipment as specified in CAN/CSA-C22.2 No. 60950-1, Information Technology Equipment-Safety - Part 1: General Requirements. Such products or components include, but are not limited to:
 - A Hubs;
 - B Routers;
 - C Network interface devices;
 - D Third party communications service providers;
 - E Digital subscriber line (DSL) modems; and
 - F Cable modems

False Alarm Reduction Programmable Options *

25.1 Shipping Defaults and Recommended Programming for ANSI/SIA CP-01-2010

SIA CP-01 FEATURE PARAGRAPH # AND DESCRIPTION	DMP XR500 PROGRAMMING GUIDE LT-0679 SECTION #	REQUIREMENT	RANGE	SHIPPING DEFAULT	RECOMMENDED PROGRAMMING*
4.2.2.1 Exit Time	15.2 Exit Delay	Required (Programmable)	45 sec. - 250 sec.	60 Seconds	60 Seconds
4.2.2.2 Progress Annunciation	15.2 Exit Delay	Allowed	Individual keypads may be disabled per zone	All keypads enabled	All keypads enabled
4.2.2.3 Exit Time Restart	15.2 Exit Delay	Required Option	For re-entry during exit time	Enabled	Enabled
4.2.2.5 Auto Stay Arm on Unvacated Premises	33.3 Occupied Premise - See XR500 Install Guide (LT-0681)	Required Option (except for remote arming)	Area 1 = Perimeter Area 2 = Interior	Enabled	Enabled for Residential Applications
4.2.4.4 Exit Time and Progress Annunciation/ Disable - for Remote Arm	Not Available on Remote Arming	Allowed Option	Progress Annunciation Always disabled for Remote Arming	Not Available	Remote Arming not allowed for CP-01 installations.
4.2.3.1 Entry Delay(s)	8.3 Entry Delay	Required (Programmable)	30 sec. - 240 Sec. **	30 Seconds	At least 30 Seconds **
4.2.5.1 Abort Window - for Non-Fire Zones	3.7 Transmit Delay	Required Option	Disable by zone or zone type	Enabled NT DY EX Zone	Enabled
4.2.5.1 Abort Window Time - for Non-Fire Zones	3.7 Transmit Delay	Required (Programmable)	15 sec. - 45 sec. **	30 Seconds	At least 15 Seconds **
4.2.5.1.2 Abort Annunciation	3.7 Transmit Delay	Required Option	Annunciate that no alarm was transmitted (S45)	Yes	Yes
4.2.5.4.1 Cancel Annunciation	Always Enabled - Not Programmable	Required Option	Annunciate that a Cancel was transmitted (S49)	Always Enabled	Yes
4.2.6.1 & 4.2.6.2 Duress Feature	User Code + 1 = Ambush Code Not Available	Allowed Option	No 1 + derivative of another user code/no duplicates with other user codes	Code +1 Always Disabled	Not Programmable
4.3.1 Cross Zoning	16.22 Cross Zone	Required Option	Yes/No Zone Programming	No	Enabled using two or more programmed zones
4.3.1 Programmable Cross Zoning Time	8.4 Cross Zone Time	Allowed	4 sec. - 250 sec.	4 Seconds	Per walk path in protected premises
4.3.2 Swinger Shutdown	8.7 Swinger Bypass Trips	Required (Programmable)	For all non-fire zones, shut down at 1 or 2 trips	One (1) trip	One (1) trip
4.3.2 Swinger Shutdown Disable	16.16 Swinger Bypass	Allowed	For non-police response zones	Yes	Enabled (all zones)
4.3.3 Fire Alarm Verification	16.4 Zone Type	Required Option	FV Type Zone	No	Yes as required (unless sensors can self verify)
4.5 Call Waiting Cancel	3.19 Telephone Number	Required Option	Include *70P in Telephone Number	Disabled	Enabled if user has call waiting

* Programming at installation may be subordinate to other listed requirements for the intended application.

** For listed Installations, combined Entry Delay and Transmit Delay should not exceed 1 minute.

False Alarm Reduction Programmable Options (continued)

25.2 Call Waiting (ANSI/SIA CP-01-2010)

The Call Waiting default setting is disabled. To cancel the Call Waiting feature, program * (star) 7 0 P (pause), the standard telephone code prefix that cancels call waiting, into the telephone number string. Cancel Call Waiting for telephone lines that have Call Waiting operational on the telephone line. See the XR500 Series Canadian Programming Guide (LT-0679CAN).



Caution: A call waiting cancel programmed on a non-call waiting telephone line, would prevent communication to the central station.

25.3 Occupied Premise (ANSI/SIA CP-01-2010)

When only two areas are used, and area one is named Perimeter, and area two is named Interior, and no exit type zone transition occurs during the exit delay because the premise continues to be occupied, the Interior area will automatically disarm at the end of the exit delay.

25.4 Entry Delay (ANSI/SIA CP-01-2010)

Only use Entry Delay 1. Do not use Entry Delay 2, 3, or 4. See the XR500 Series Canadian Programming Guide (LT-0679CAN).

25.5 Minimum Installation Requirements (ANSI/SIA CP-01-2010)

SIA CP-01-2010 minimum system installation requirements include an XR500, a listed local Bell, and off premise DACT communication to an SCS-1R receiver plus one of the following compatible keypads.

- 7060, 7063, 7070, or 7073 Thinline™ keypads
- 7060A, 7063A, 7070A, or 7073A Aqualite™ keypads
- 7160, 7163, 7170, or 7173 Thinline™ keypads

Wiring Diagrams

26.1 Rothenbuhler 5110 High Security Bell Wiring

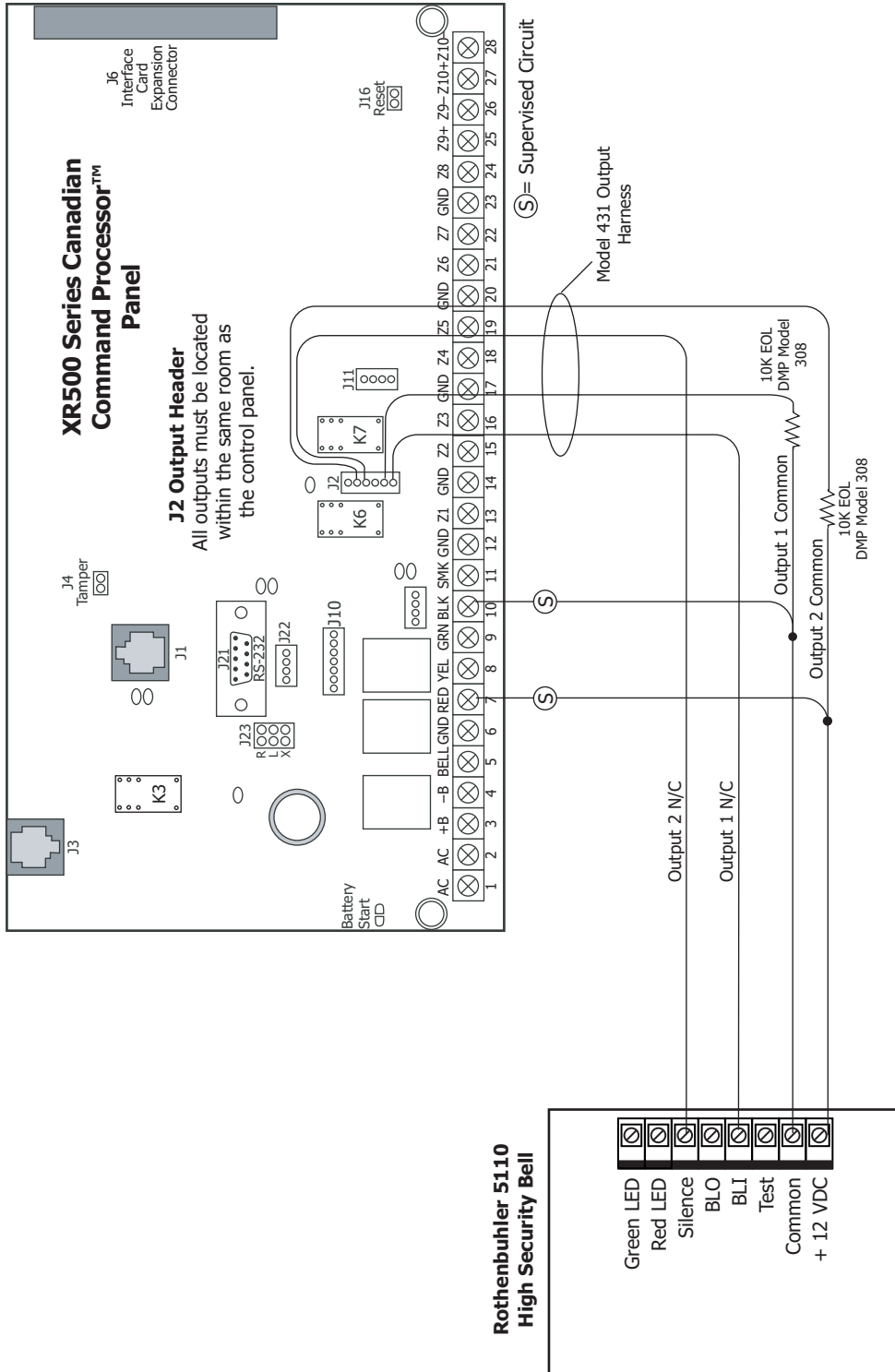

26.2 LX-Bus™ Module Connection

LX-Bus Expansion
Interface Card
DMP Models 481, 462N,
462P, 463G, or 472

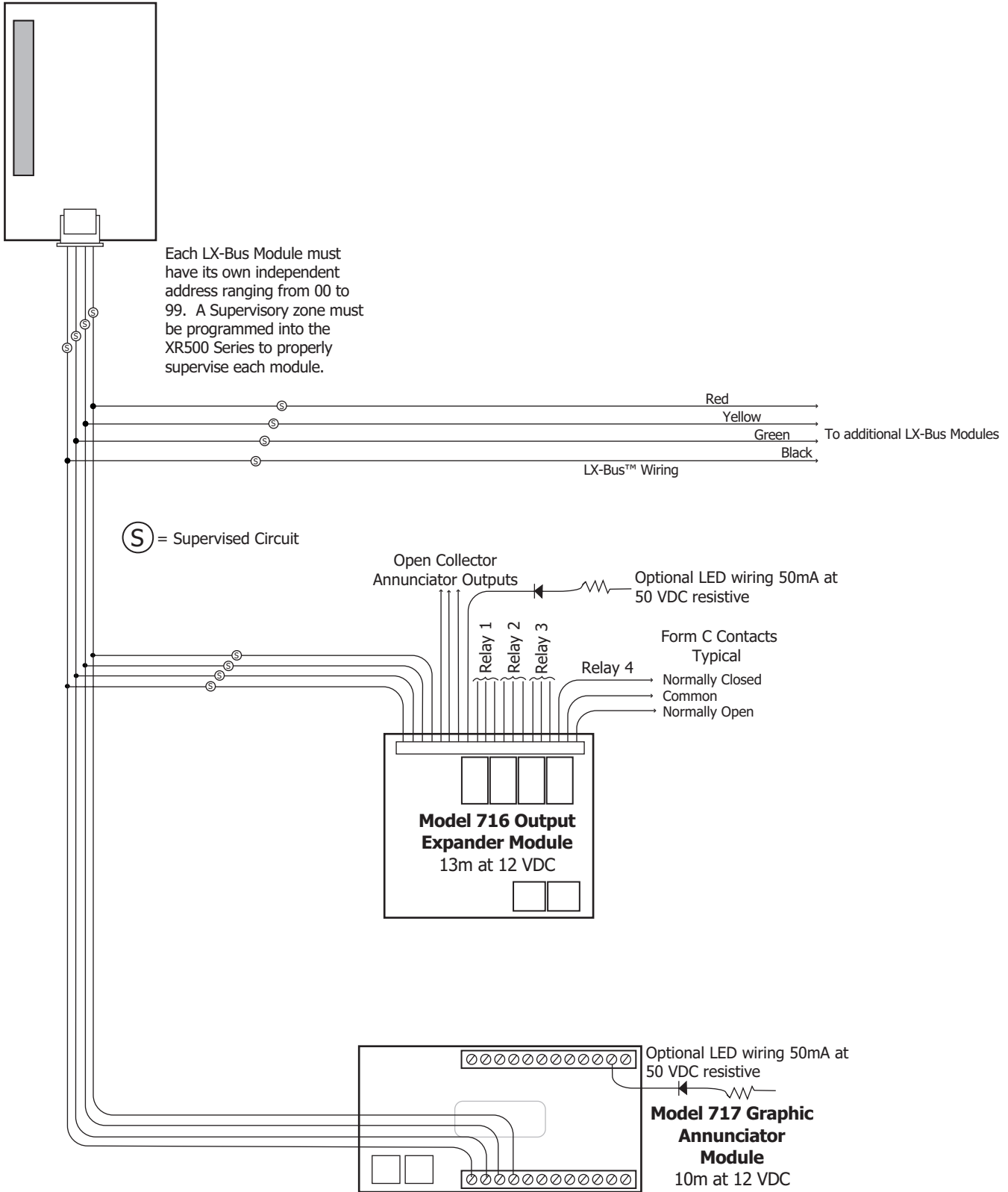

26.3 Model 860 Relay Module Connection

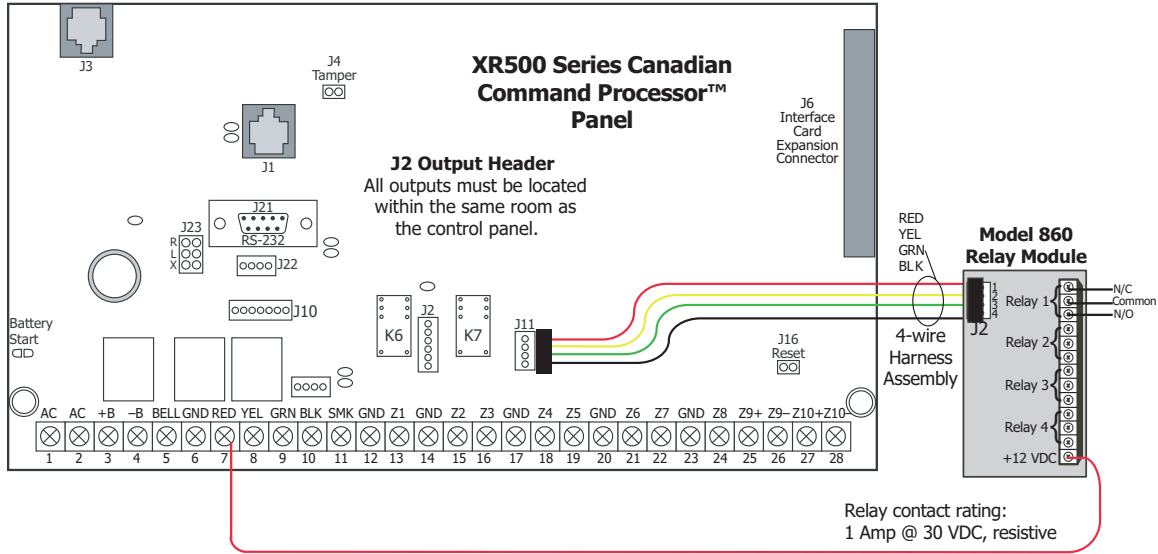

26.4 Dual Zone Protection

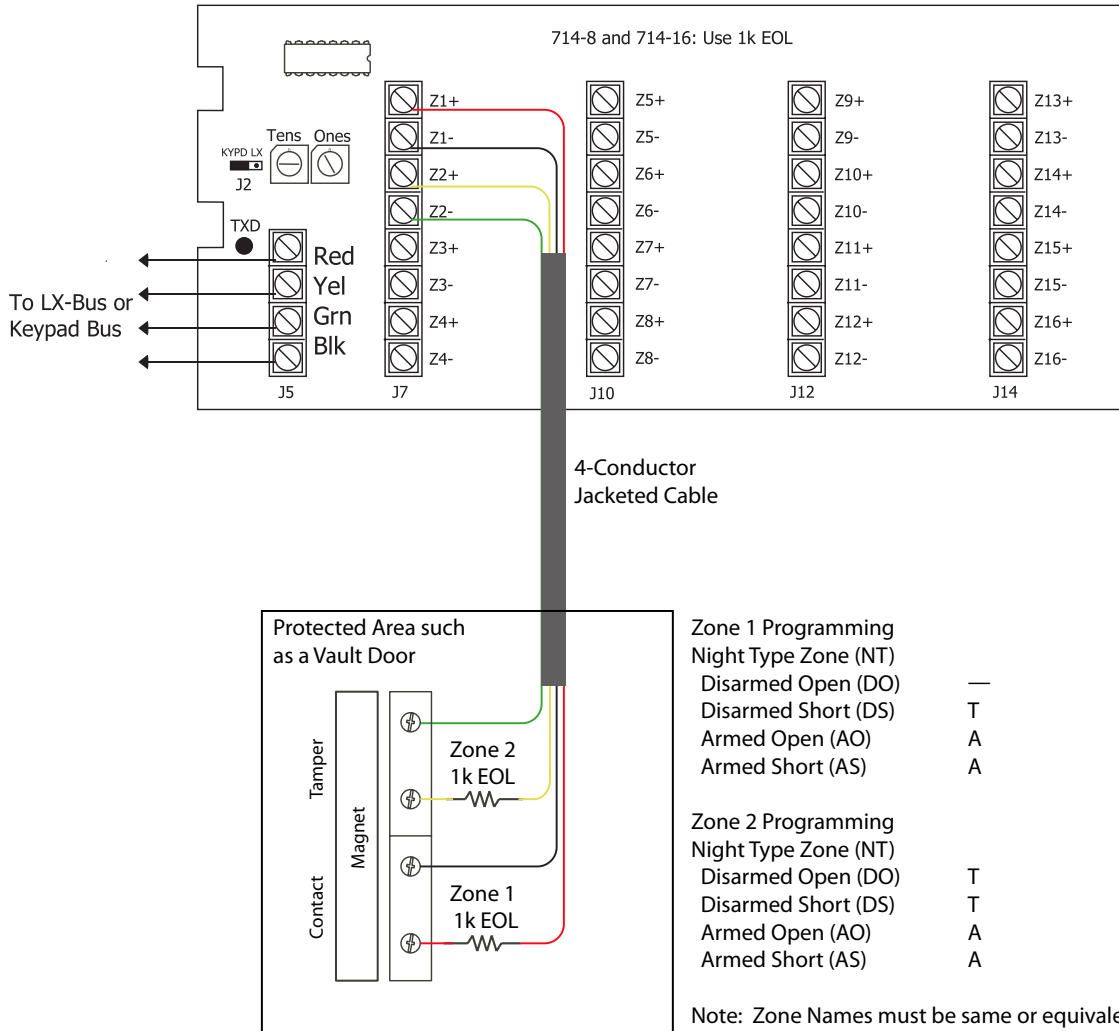

26.5 Canadian Fire Communicator for FACP

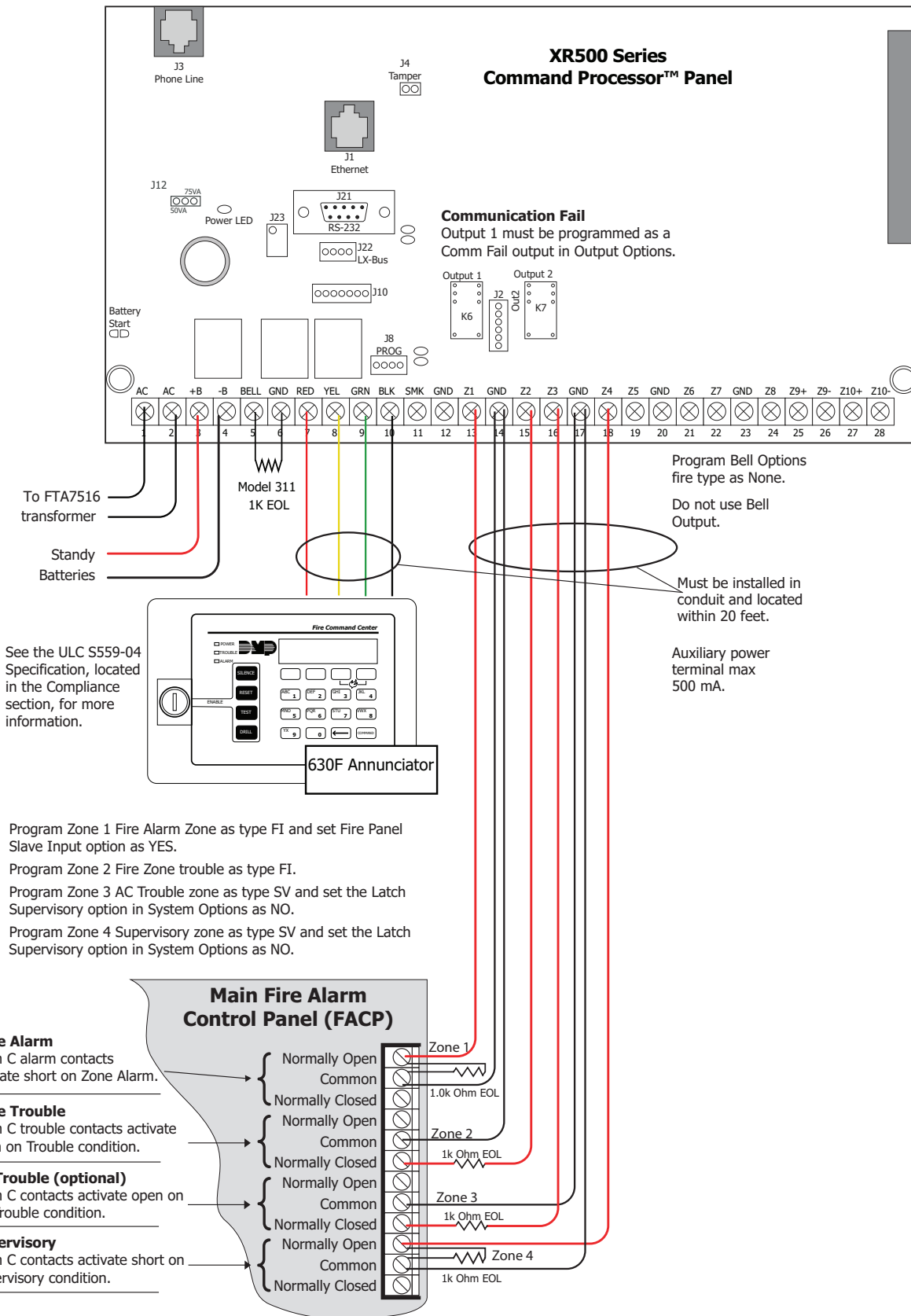

26.6 Combination S304 and S559 System

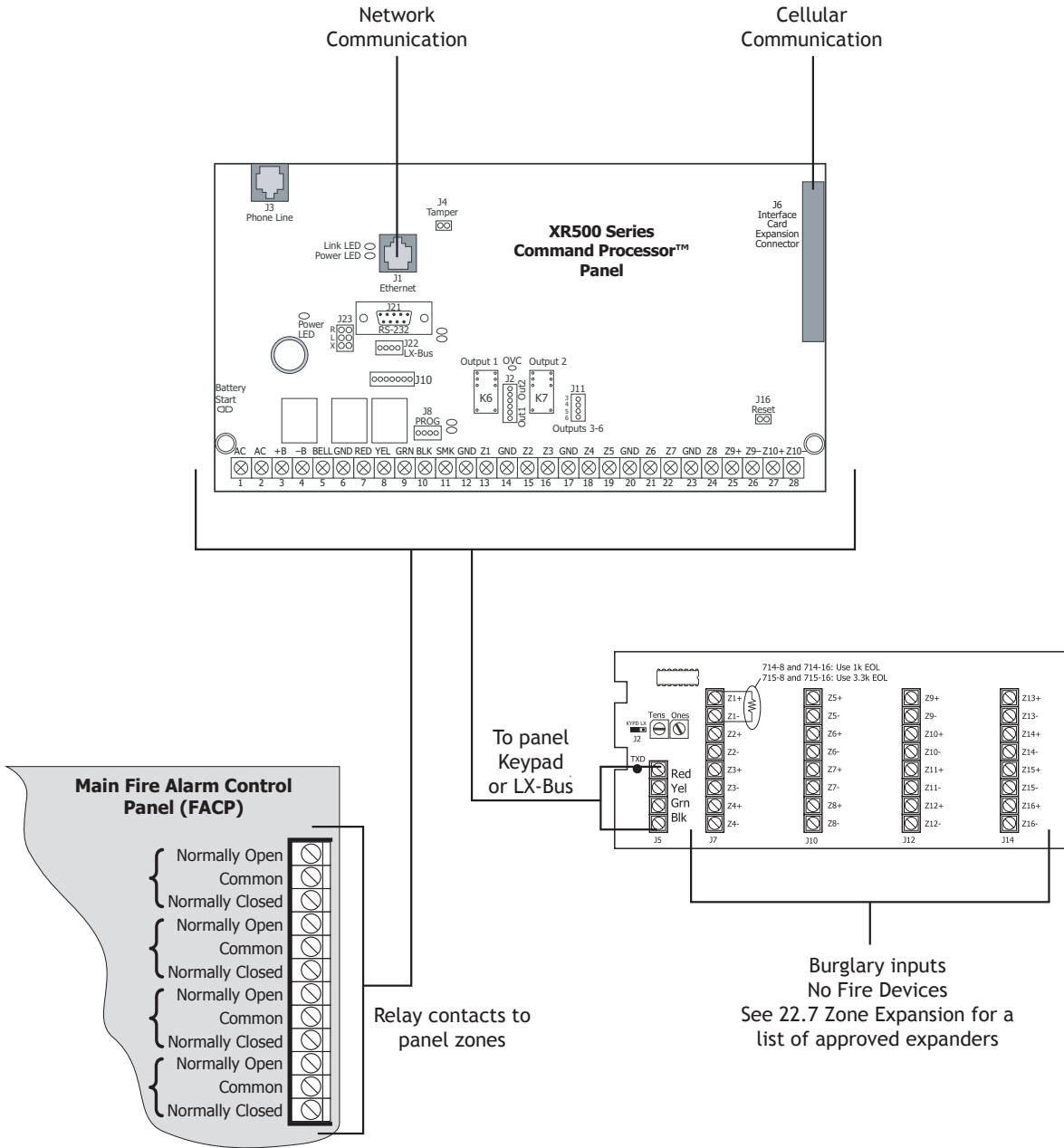

26.7 System Sensor 2-Wire Smoke Detectors

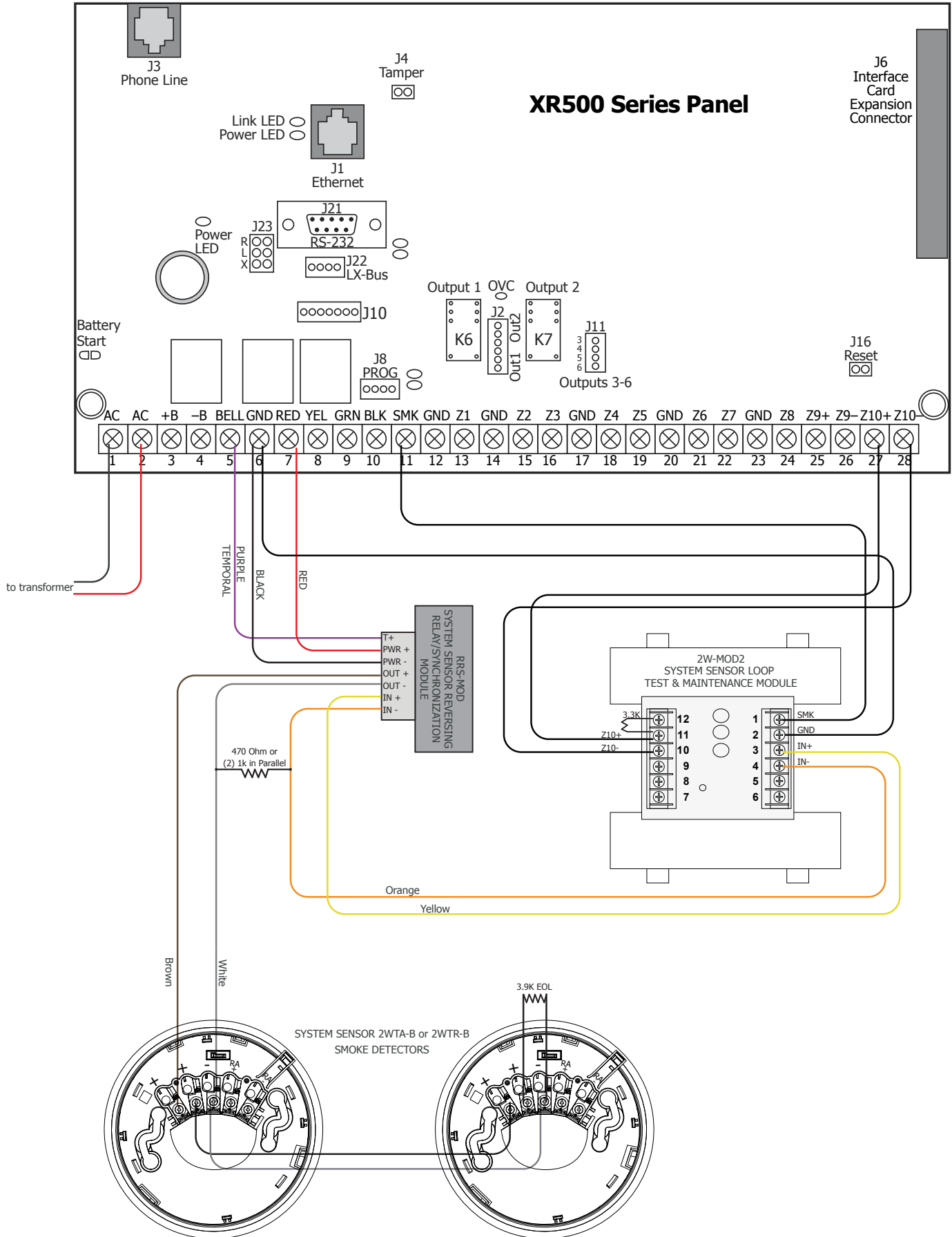

Revisions to This Document

This section explains the changes that were made to this document during this revision. This section lists the version, section number with heading, and a quick summary of the change.

Version	Section Number and Heading	Summary of Changes
1.16	3.4 Accessory Devices	Added 734N/734N-WiFi and removed 1161/1162
	6.8 Power Requirements	Added 734N/734N-WiFi
1.15	11.2 Compatible 2-Wire Smoke	Added 2WTA-B and 2WTR-B System Sensor smoke detectors
	26.7 System Sensor	Added diagram
1.14	3.4 Accessory Devices	Added reference for 1184 CO Detector
1.13	22.7 Zone Expansion	Added section
	23.1 Fire Communicator Applications	Removed Cell primary/Net backup option
	26.5 Canadian Fire Communicator	Updated for Burglary/Fire Communicator operation
	26.6 Combination S304 and S559	Added diagram
1.12	22.6 Remote Arming	Removed ULC remote programming restrictions
1.11	23.1 Fire Communicator Applications	Added section
	23.2 Central Station Host Automation	Added section
	26.5 Canadian Fire Communicator	Added diagram
1.10	1.4 Keypad Bus	Added Wireless Keypads
	3.4 Accessory Devices	Added 1135 Wireless Sounder and 9000 Series Wireless Keypads Removed 690, 790, 693/793, 1100XI, and 1105-EOL
	4.1 Mounting the Enclosure	Added information about 350A
	4.4 Wireless Keypad Association	Added section
	6.8 XR100 Series Power Requirements	Removed 1100XI, 690, 693/793, and 790
	15.2 J22 LX-Bus Expansion Connector	Added 1100XH to Wireless Bus Operation.
	24.5 Minimum Install Requirements	Removed 690, 790, 693/793

Listings and Approvals

This Class A digital apparatus complies with Canadian ICES-003

NIST Validated XR500E Encrypted Command Processor Panel Certificate #130

ANSI/SIA CP-01-2010 False Alarm Reduction

Underwriters Laboratories Canada (ULC) Listed

ULC-S559-04 Equipment for Fire Signal Receiving Centers and Systems

ULC S545 Household Fire

ULC Subject-C1023 Household Burglar

ULC/ORD-C1076 Proprietary Burglar

ULC S304 Central Station Burglar



800-641-4282

www.dmp.com

Made in the USA

INTRUSION • FIRE • ACCESS • NETWORKS

2500 North Partnership Boulevard

Springfield, Missouri 65803-8877

LT-0681CAN 1.16 © 2012 Digital Monitoring Products, Inc.

